



Requirements for Connection of New Facilities or Changes to Existing Facilities Connected to the AEP Transmission System

Effective January 1, 2019

 AMERICAN ELECTRIC POWER® BOUNDLESS ENERGY™	TRANSMISSION PLANNING GUIDELINE Requirements for Connection of New Facilities or Changes to Existing Facilities Connected to the AEP Transmission System	Rev. 2	TP-0001
			Page 1 of 99

DOCUMENT CONTROL

Preparation

ACTION	NAME(S)	TITLE
Prepared by:	Corey B Cottrell James B Smith Jonathan Riley N Alan Ward Daniel T Zambory	Senior Engineer Senior Engineer Senior Engineer Manager-West Transmission Customer Engagement Manager-East Transmission Customer Engagement
Reviewed by:	Michele Bair	Director, Transmission Customer Engagement
Reviewed by:	Kamran Ali	Director, East Transmission Planning
Reviewed by:	Wayman L Smith	Director, West Transmission Planning
Approved by:	Robert W. Bradish	Vice President, Transmission Planning & Engineering

Review Cycle

Quarterly	Semi-annual	Annual	As Needed X
-----------	-------------	--------	-----------------------

Revision History

VERSION	EFFECTIVE DATE	FILE NAME	REMARKS
Rev 0	12-08-2010	AEP_Interconnection_Requirements_rev0.pdf	Combined AEP East and AEP West Interconnection Requirements
Rev 1	01-02-2014	AEP_Interconnection_Requirements_rev1.pdf	Periodic Review
Rev 2	01-01-2019	AEP_Interconnection_Requirements_rev2.pdf	New FAC-001-3 Requirements Appendix B Rework Periodic Review

Distribution

NAME(S)	DEPARTMENT	TITLE
Michele Bair	Transmission Customer Engagement	Director
Kamran Ali	East Transmission Planning	Director
Wayman L Smith	West Transmission Planning	Director
Robert L Pennybaker	Transmission Interconnection Services	Director
N Alan Ward	Transmission Customer Engagement	Manager
Daniel T Zambory	Transmission Customer Engagement	Manager
AEP OASIS Site	https://www.aep.com/requiredpostings/AEPTransmissionStudies	

TABLE OF CONTENTS

1.0 Transmission Operations Requirements 7

1.1 Advance In-Service Coordination 7

1.2 Transmission Service and NERC Registration 7

1.3 Voltage Schedule and Coordination Requirements 7

1.3.1 Coordination of Scheduled Outages 7

1.4 Meter Agent and Transmission Settlement Requirements 8

1.5 Station Load and Ancillary Service Provider 8

1.6 Inspection Requirements 8

1.7 Coordination with Other Codes, Standards, and Agencies 8

1.8 Indemnification 9

1.9 Substation Equipment, Insulation, Structural, and Conductor Requirements..... 9

1.9.1 Surge Arresters 9

1.9.2 Substation Static Wires 10

1.9.3 Size and Take-Off Tension of Line Conductors and Overhead Ground Wires 10

1.9.4 Substation Ground Grid..... 10

1.10 Substation Fence..... 10

1.11 Dead-End Structures..... 11

1.12 Bus Heights and Phase Spacing 11

1.13 Structure Loading 11

1.14 Equipment Structures 11

1.15 Steel in Coastal and Industrial Corrosive Environments 11

1.16 Substation Lighting 12

1.17 AC Station Service System 12

1.18 DC Station Service System 12

1.19 Fusing of Potential Transformers 12

1.20 Transformer Protective Devices, and other Requester Facilities 12

1.21 Fault Interrupting Devices 12

1.22 Control Cable 13

1.23 Capacitors..... 13

1.24 Wavetrap, CCVT’s, PT’s and CT’s Guidance..... 14

1.25 Insulation..... 15

1.26 Metering Requirements 16

1.27 SCADA Requirements 17

1.28 RTU Requirements..... 18

1.29 Circuit Requirements..... 18

1.30 Demark Requirements..... 19

1.31 High Voltage Isolation Requirements 19

1.32 Access Plan Requirements 20

1.33 Fiber Optic Cable Requirements 20

1.34 All-Dielectric Fiber Optic Cable Requirements 21

2.0 Generator Connection (GC) Facilities - Connection Requirements 22

2.1 Generator Connection Options 22

2.1.1 Parallel Connection 23

2.1.2 Separate Connection..... 23

2.2 Information Required from Generator Connection Requester..... 24

2.3 Design Requirements and Considerations 30

2.4 Voltage Requirements 30

2.5 Power Factor Requirements 31

2.6 Power Quality Requirements..... 31

2.7 Frequency Requirements 31

2.8 Abnormal Frequency Operation 31

2.9 GSU Configurations 31

2.10 Induction Generators 32

2.11 Inverter Systems32

2.12 Wind Generation Requirements32

 2.12.1 Low Voltage Ride-Through (LVRT) Capability 33

 2.12.2 Power Factor Requirements 33

 2.12.3 System Grounding 33

 2.12.4 Transient Stability Performance 33

 2.12.5 Excitation Control 33

 2.12.6 Speed Governing 33

 2.12.7 Automatic Generation Control 33

 2.12.8 Black Start Capability..... 33

 2.12.9 Sub-Synchronous Torsional Interactions or Resonance 34

 2.12.10 Metering/SCADA..... 34

 2.12.11 Voice Communications 34

2.13 Transmission Line Design, Loading, Clearance, Insulation and Structural Design Requirements 34

 2.13.1 New Transmission Lines Serving only the Requester and not Owned by AEP 34

 2.13.2 New Transmission Lines Serving the Requester and Integrated in the AEP Network 35

2.14 Dynamic MVAR Capability Requirements..... 35

2.15 Disturbance Monitoring Requirements 35

2.16 Coordination of Protective Systems 35

 2.16.1 Placement of Generation Monitoring Equipment..... 35

 2.16.2 Generation Monitoring Equipment placed at the AEP substation 35

2.17 Ownership, Cost, Maintenance and Compliance Responsibility 36

2.18 Generator Connection Final Approval 36

3.0 Transmission Interconnection (TI) Facilities – Connection Requirements, Typical Network Interconnections. 37

 3.1 Design Information..... 37

 3.2 General Operating and Design Requirements 38

 3.3 Power Quality Requirements..... 38

 3.4 System Protection Requirements..... 38

 3.5 Ownership, Cost, Maintenance and Compliance Responsibility..... 38

 3.6 Metering/SCADA..... 39

 3.7 Voice Communications 39

 3.8 Transmission Line Design, Loading, Clearance, Insulation and Structural Design Requirements 39

 3.8.1 New Transmission Lines Serving only the Requester and not Owned by AEP 39

 3.8.2 New Transmission Lines Serving the Requester and Integrated into the AEP Network..... 39

 3.9 Asynchronous Network Interconnections..... 39

 3.9.1 Design Information..... 39

 3.10 General Operating and Design Requirements 40

 3.11 Power Quality Requirements..... 41

 3.12 System Protection Requirements..... 41

 3.13 Information Required from Converter Station Operator 41

 3.14 Ownership, Cost, and Maintenance Responsibility 41

4.0 End-User Connection (EUC) Facilities - Connection Requirements 42

 4.1 Design Information..... 42

 4.2 General Operating Requirements 44

 4.3 Power Factor 44

 4.4 Power Quality Requirements..... 44

 4.5 Under frequency Load Shedding..... 44

 4.6 Load Connection Definitions and Requirements..... 44

 4.6.1 Radial Load Connection Definition and Requirements 44

 4.6.2 Looped Load Connection Definition and Requirements 45

 4.7 Transmission Line Design, Loading, Clearance, Insulation and Structural Design Requirements 45

 4.7.1 New Transmission Lines Serving only the Requester and not Owned by AEP 45

 4.7.2 New Transmission Lines Serving the Requester and Integrated into the AEP Network..... 46

 4.8 Information Required from End-User 46

 4.9 Ownership, Cost, Maintenance and Compliance Responsibility..... 47

CAUTION: Printed copies of this document are uncontrolled and may be obsolete.
Always check for the latest revision prior to use.

4.10 Metering/SCADA.....47
4.11 Voice Communications47

Appendices

A: AEP Power Quality Requirements48
B: Connection Diagrams54
C: Electrical Clearances and Equipment Ratings60
D: 800 kV Major Equipment Specifications62
E: AEP Metering Requirements for Transmission Interconnection Facilities.....65
F: AEP SCADA RTU Requirements for Transmission Interconnection Facilities71
G: AEP Protection and Disturbance Monitoring Requirements for Connecting to the AEP Transmission Grid79
H: Transmission Switching Guidelines for In-Line Stations.....86
I: Procedures, Studies, and Documentation Required for Interconnection Requests94

INTRODUCTION

This document describes the processes and technical requirements for new or materially modified¹ facility connections to the American Electric Power (AEP) System's electrical transmission network.

AEP's Transmission Planning departments are responsible for evaluating the capability of the AEP transmission network's capabilities and formulating plans that maximize functionality and operation in a safe, reliable, cost effective, and environmentally-responsible manner. Transmission Planning developed the requirements in this document to ensure the transmission system's integrity when providing new or materially modified facility connections. It is the responsibility of the Generator Connection, Transmission Interconnection or End-User Connection entity to obtain the requirements from the RTO/ISO region within which their operation exists.

For purposes of this requirements document, AEP transmission interconnections will be organized into the following three categories:

- 1. Common Requirements for all types of Transmission Interconnections**
- 2. Generator Connection (GC)** – Affiliated or non-affiliated generating facility seeking initial connection or an existing connected generating facility that is changing capacity or operating characteristics.
- 3. Transmission Interconnection (TI)** – Also known as a network interconnection, transmission-to-transmission interconnection, interconnection point, or point of interconnection. Power is expected to flow in either direction with this type of connection. Connecting the AEP transmission grid to the transmission system of a neighboring utility is an example of this type of connection.
- 4. End-User Connection (EUC)** – Sometimes referred to as a load connection or a transmission load connection. The entity with this type of connection consumes all of the energy delivered or ultimately delivers the power to individual users. A “delivery point” or “point of delivery” (POD) is associated with this type of connection and power is allowed to flow in one direction, from the AEP transmission system to the End-User Connection Requester. Industrial facilities and other load-serving entities such as electric cooperatives and municipals would be examples of this type of connection. Nothing herein should be construed to imply the provision of electric service directly to any retail consumer.

This document contains the minimum requirements acceptable for both affiliated and non-affiliated connections to the AEP transmission system. The processes and requirements contained within this document will guide the planning of new facility installations as well as the upgrading of existing facilities, and may need to be supplemented with additional details in some specific cases.

Customers requesting a new or modified connection to the AEP electrical transmission system should reference Section 2.2 which outlines the procedures for initiating an interconnection request.

AEP OPERATING COMPANIES AND RTO/ISO MEMBERSHIP

AEP has eleven electric utilities referred to as Operating Companies, and seven electric utilities referred to as Transmission Companies that are geographically dispersed across eleven states.

Regional Transmission Organizations (RTOs) and Independent System Operators (ISOs) support and assist with the operation and utilization of the larger integrated or interconnected regional transmission system and are generally charged with ensuring the safe and reliable operation of the regional transmission system. Nothing within this document is intended to conflict with applicable RTO/ISO requirements.

¹ For the purpose of compliance with NERC Standards FAC-001 and FAC-002, a Facility is considered to be materially modified if BES contingencies are altered as a result of the modification or there is a significant change in load or generation levels.

 AMERICAN ELECTRIC POWER BOUNDLESS ENERGY™	TRANSMISSION PLANNING GUIDELINE Requirements for Connection of New Facilities or Changes to Existing Facilities Connected to the AEP Transmission System	Rev. 2	TP-0001
			Page 6 of 99

The operating and transmission companies within AEP² are members of RTOs/ISOs as shown in the tables below:

Operating Company	RTO/ISO
AEP Texas	ERCOT ³
Appalachian Power Company	PJM ⁴
Indiana Michigan Power Company	PJM
Kentucky Power Company	PJM
AEP Ohio	PJM
Public Service Company of Oklahoma	SPP ⁵
Southwestern Electric Power Company	SPP

Transmission Company	RTO/ISO
AEP Appalachian Transmission Company	PJM
AEP West Virginia Transmission Company	PJM
AEP Indiana Michigan Transmission Company	PJM
AEP Kentucky Transmission Company	PJM
AEP Ohio Transmission Company	PJM
AEP Oklahoma Transmission Company	SPP
AEP Southwestern Transmission Company	SPP

Note: Entities requesting a Transmission Interconnection are required to register within a Balancing Authority (BA) with their respective RTO. The interconnecting facilities will not be energized until it can be verified that this registration is complete.

COMMON REQUIREMENTS FOR ALL TYPES OF TRANSMISSION INTERCONNECTION: GENERATOR, TRANSMISSION AND END USER.

1.0 TRANSMISSION OPERATIONS REQUIREMENTS

Transmission Operations must manage and operate transmission and interconnection facilities based on NERC, Regional, and applicable RTO/ISO reliability standards. This section outlines the operational requirements of the Generation and Transmission Interconnection Requester.

1.1 Advance In-Service Coordination

The Requester shall provide the AEP Project Manager an advanced written notice of their GC or TI facility in-service date. The greater of 45 days or any RTO/ISO in-service date notification requirements will be used as the advanced written notice time constraint. AEP Transmission Operations will use this time period to ensure that telemetry, system models(s), communication and procedures of all stakeholders are verified.

1.2 Transmission Service and NERC Registration

The Requester is required to register with NERC to establish the interconnection or generation source/sink prior to being granted transmission service. The Requester shall provide AEP with this NERC registration information at least 30 days before in-service date.

1.3 Voltage Schedule and Coordination Requirements

The Requester's generating equipment shall not cause excessive voltage excursions. AEP shall coordinate with the Requester and the RTO/ISO to establish the normal operating voltage schedule, power factor schedule and operating limits. During emergency system conditions, the Requester's generation facilities shall comply with all special instructions provided by AEP Transmission Operations. Reference Appendix A (AEP Power Quality Requirements) for further details regarding voltage requirements.

1.3.1 Coordination of Scheduled Outages

The Requester shall provide a schedule of all planned equipment outages to AEP and the RTO/ISO, and follow the applicable outage coordination procedures. At least 7 days advance notice is required; this period may be extended depending on the RTO/ISO.

² AEP Service Corporation is an agent for Electric Transmission Texas (ETT) and Electric Transmission America (ETA).

³ ERCOT (Electricity Reliability Council of Texas) ISO region represents the entire Texas Interconnection, which comprises nearly all of the state of Texas.

⁴ PJM (Originated from Pennsylvania – New Jersey – Maryland Interconnection) RTO is part of the Eastern Interconnection, operating an electric transmission system serving all or parts of Delaware, Illinois, Indiana, Kentucky, Maryland, Michigan, New Jersey, North Carolina, Ohio, Pennsylvania, Tennessee, Virginia, West Virginia and the District of Columbia.

⁵ SPP (Southwest Power Pool) RTO lies within the Eastern Interconnection and has members in nine states: Arkansas, Kansas, Louisiana, Mississippi, Missouri, Nebraska, New Mexico, Oklahoma, and Texas.

1.4 Meter Agent and Transmission Settlement Requirements

- a. All interconnecting facilities metering shall comply with the Metering Articles as set forth in the executed LGIA, IA, or ILDSA.
- b. The Requester shall provide AEP with hourly integrated MWh metering information for transmission settlement purposes. Reference Section 8.1 (Transmission Interconnect Metering Requirements) for details regarding generation facility metering.
- c. In the SPP region, the Requester must be a signatory of a completed current SPP pro forma Attachment AM "Meter Agent Services Agreement for SPP Market Participant and Meter Agent" and be bound by the requirements of the agreement.
- d. In the case of a GC where there is a power purchase agreement in place among multiple off-takers, it is the responsibility of the GC to provide the appropriate daily splits of the generator output among the off-takers. As meter agent, AEP will report the splits to the RTO. If it is subsequently determined that the splits were incorrect, AEP Transmission will not be held financially liable. Any resulting financial responsibilities will need to be resolved between the GC and the off-takers.
- e. The Requester shall coordinate with AEP to establish an after-the-fact daily MWh meter checkout process and procedure, so as to comply with all RTO/ISO reporting deadlines.

1.5 Station Load and Ancillary Service Provider

The Requester shall establish its station load and ancillary service provider agreements. The Requester shall also provide AEP with current copies of the agreements.

1.6 Inspection Requirements

Before a Requester-owned facility can be energized, it must pass applicable inspections by AEP personnel. A Transmission Construction Representative (TCR) will retain a construction clearance on the site until the customer fulfills all of their construction requirements. An AEP Protection and Control (P&C) staff member may retain clearances until all desired/necessary checkouts are completed. AEP at its discretion and choice will inspect all substation equipment from the point of interconnection to the first protective fault interrupting device and the ground system. This may include circuit breakers, circuit switchers, power fuses, instrument transformers, switches, surge arresters, bushings, and relays and associated equipment including battery, battery chargers or other customer equipment. The inspection may consist of a visual inspection of all major equipment as well as a review of required test results.

The ground system must be checked by the Requester using the resistance measurement procedures in accordance with IEEE Standard 81 "Recommended Guide for Measuring Ground Resistance and Potential Gradients in the Earth." These results shall be shared with the AEP TCR prior to energizing the Requester's facilities. By AEP energizing the Requester's facilities, it shall not be construed as AEP's approval of the adequacy of the Requester's facilities. All future Requester facilities, loads, major equipment or setting changes shall be submitted to AEP for review prior to being placed in service. This is required to assure the integrity and safe operation of the transmission system. Costs for studies performed in these situations may be billed to the Requester depending upon the scope of the necessary study. The Transmission Planner will determine if a Requester study agreement is required.

1.7 Coordination with Other Codes, Standards, and Agencies

The information contained in this document is supplemental to and does not intentionally conflict with or supersede the National Electrical Code (NEC) as approved by the American National Standards Institute (ANSI) or such federal, state and municipal laws, ordinances, rules or regulations as may be in force within the cities, towns or communities in which AEP furnishes electric service. It is the responsibility of the Requester to conform to all applicable national, state and local laws, ordinances, rules, regulations, codes, NERC Reliability Standards, Regional Reliability Standards, etc. The Requester's responsibility in this instance begins at the point of ownership described in the Interconnection Agreement (IA).

 AMERICAN ELECTRIC POWER BOUNDLESS ENERGY™	TRANSMISSION PLANNING GUIDELINE Requirements for Connection of New Facilities or Changes to Existing Facilities Connected to the AEP Transmission System	Rev. 2	TP-0001
			Page 8 of 99

1.8 Indemnification

The use and reliance upon the information contained in this document shall in no way relieve the Requester from the responsibility to meet NEC and NESC requirements governing their design, construction, operation, and materials.

The Requester, for itself, its successors, assigns and subcontractors will be required to pay, indemnify and save AEP, its successors and assigns, harmless from and against any and all court costs and litigation expenses, including legal fees, incurred or related to the defense of any action asserted by any person or persons for bodily injuries, death or property damage arising or in any manner growing out of the use and reliance upon the information provided by AEP. Reliance upon the information in this document shall not relieve the Requester from responsibility for the protection and safety of the general public within the Requester's facilities as defined in the Interconnection Agreement (IA).

1.9 Substation Equipment, Insulation, Structural, and Conductor Requirements

When the point of service is determined, the Requester shall adhere to current AEP construction, insulation, site, and structural practices and standards for new facilities that will be connected to the AEP electric system. The Requester shall ensure AEP standard warranties are in effect for all procured equipment that will be transferred to AEP. (Consult AEP for warranty requirements.) In rare cases, AEP may grant variances to standards. For proposed facilities on the AEP-side of the interconnections, AEP will review project plans with the Requester before work begins.

The following is a summary of general requirements and construction guidance concerning the design of AEP substation facilities and Requester substation facilities that will interconnect to AEP facilities. More detailed information on AEP requirements may be obtained by contacting the AEP Project Manager or designee.

1.9.1 Surge Arresters

The lightning arrester ratings recommended by AEP are shown in the table below. Arrester applications for 230 kV and above need to be evaluated on case-by-case basis because of the special duty placed on the arresters due to switching surge capabilities. The AEP Project Manager or designee can provide more information on this topic. Characteristics of the units to be installed shall be provided to AEP prior to construction.

AEP Standard Arrester Ratings

System kV	Duty-Cycle Voltage (kV)	Maximum Continuous Operating Voltage (MCOV) (kV)
69	60	48
115	90	70
138	108	84
161	120	98
230	**	**
345	**	**
765	**	**

Arrester selection shall conform to IEEE STD C62.22.

1.9.2 Substation Static Wires

The Requester shall provide locations and attachments for required AEP static wires that will be terminated on Requester's facilities. Loading requirements will be determined on a case-by-case basis by AEP.

1.9.3 Size and Take-Off Tension of Line Conductors and Overhead Ground Wires

The Requester's structure shall be designed with the specific quantity, size and type of phase conductors and overhead ground wire(s) as determined by AEP for each request. The approximate take-off or dead-end tension for each phase conductor and each overhead ground wire must be in accordance with Rule 250 of the National Electrical Safety Code (NESC). The exact take-off tensions will be determined after the facility plans are finalized.

The line terminal connectors furnished by the Requester should be (copper or aluminum) wire-and-pad connectors to bolt to and be materially compatible with the air switch terminal pad. The overhead ground wire shall be grounded using aluminum compression wire and a pad type connector furnished by the Requester.

If the incoming high voltage lines will cross waterways, roadways or railroad tracks (such as a siding or main line) in order to reach the Requester's facility, it may be necessary to increase the above tensions or provide additional height on the structure(s) to meet appropriate crossing requirements.

The point of attachment of the line entrance conductors shall be of sufficient height to provide the basic vertical clearance requirements for lines crossing over public streets, alleys, or roads in urban or rural districts, as outlined in the NESC.

1.9.4 Substation Ground Grid

Personnel safety is the primary objective of an adequate grounding system. The ground grid must be designed to limit surface potential gradients to safe values in accordance with ANSI/IEEE 80. A substation grounding system shall be designed to fulfill the following requirements:

- 1) Proper grounding of equipment, structures, and installation of an adequate earth ground grid for safety to personnel. Copper-clad steel conductors are strongly encouraged as grounds to reduce the risk of outages associated with copper theft.
- 2) Grounding of system neutrals to stabilize circuit potentials with respect to earth ground, and to provide circuit relaying for clearing ground faults.
- 3) Proper equipment grounding for lightning, surge protection, and low voltage faults.
- 4) Contact the AEP Project Manager to obtain ground fault values and clearing times for AEP facilities.

The Requester shall provide to AEP design drawings and material lists for its proposed substation ground grid. Ground grid connections between AEP facilities and Requester's facilities shall be designed and installed in a manner that is acceptable to AEP. Details of substation ground grid design are contained in AEP's Station Standard #313000 "Station Ground Grid Design."

1.10 Substation Fence

AEP references the National Electrical Safety Code (ANSIC2-1993) and uses IEEE standard 1119-1988 as a guide for station fence clearances. AEP recommends the use of 7 foot fabric with three strands of barbed wire on a single bayonet which extends out of the substation at a 45° angle above the fabric. The vertical height of bayonets should be one foot resulting in a total fence height of eight feet. AEP also recommends that snake fences be used in new substation construction within certain AEP areas.

 AMERICAN ELECTRIC POWER BOUNDLESS ENERGY™	TRANSMISSION PLANNING GUIDELINE Requirements for Connection of New Facilities or Changes to Existing Facilities Connected to the AEP Transmission System	Rev. 2	TP-0001
			Page 10 of 99

1.11 Dead-End Structures

Dead-end structures must be designed to the conductor, wind, and ice loading conditions and strength requirements described in Part 25 of the NESC. A minimum of three loading conditions shall be satisfied:

- 1) NESC Heavy Loading, Grade B Construction
- 2) Extreme Wind, using the basic wind speed of 90 mph or 135 mph as appropriate for the geographical area in which the facility will be located
- 3) Combined Wind and Ice, as defined in Part 25 of the NESC

The elevations, tensions, etc., of the AEP transmission line should be considered in the Requester's site design. Consult with the applicable Transmission Line Engineer for details and guidance on the specific site/situation.

1.12 Bus Heights and Phase Spacing

AEP recommends new substation construction be designed to the bus heights and phase spacing presented in the table below. An exception to these recommendations is an addition to an existing substation where existing steel and bus heights may have to be matched. Matching existing steel is not mandatory, however.

System Voltage	BIL (kV)	Phase to Phase	High Bus	Low Bus
345 kV	1300	15'-0"	36'-2"	23'-2"
345 kV	1050	15'-0"	35'-0"	22'-0"
230 kV	900	14'-0"	26'-0"	18'-0"
161 kV	650	12'-0"	22'-0"	15'-0"
138 kV	550	10'-0"	22'-0"	15'-0"
138 kV	650	10'-0"	22'-0"	15'-0"
69 kV	350	7'-0"	18'-0"	14'-0"

Recommended Bus Heights and Phase Spacing

1.13 Structure Loading

Structures shall be designed to resist all applied loads including, but not limited to, conductor tension, wind, ice, and short circuit forces. In addition to strength requirements, structures shall be proportioned such that the load-induced deflections do not hinder the functionality of the structure and the equipment it supports. All design parameters shall follow the rules set forth by the NESC; ASCE 7, "Minimum Design Loads for Buildings and Other Structures"; ASCE Manuals and Reports on Engineering Practice No. 113, "Substation Structure Design Guide"; and other accepted industry standards.

1.14 Equipment Structures

AEP recommends the Requester's facilities located within approximately 140 miles of the Gulf of Mexico be designed for a minimum basic wind speed equal to 135 mph. AEP recommends the Requester's facilities located in all other areas of the AEP's service territory be designed for a minimum basic wind speed equal to 90 mph.

1.15 Steel in Coastal and Industrial Corrosive Environments

AEP requires the average coating thickness of hot dip galvanizing for structures installed in coastal corrosion or industrial corrosion environments to be 5.0 mils. Coastal regions in Texas are defined as the area bounded by the Gulf of Mexico and US Highway 77. All other structures shall be hot dip galvanized in accordance with ASTM A 123.

1.16 Substation Lighting

Substation lighting is needed to provide sufficient illumination at equipment locations within the substation. Service Lighting (2.0FC minimum) shall be provided at all equipment locations by High Pressure Sodium flood lights, typically 400W fixtures (below 345kV) & 1000W fixtures (345kV & above) at 30'-0" mounting height on steel light poles and/or equipment steel structure columns, and wired to a dedicated 240VAC circuit(s). With Service Lighting, personnel shall be able to observe and effectively control the operation and maintenance of various substation equipment and processes. Security Lighting (0.5FC minimum) shall be provided at all equipment locations by High Pressure Sodium open-type fixtures, typically 150W fixtures (all voltages) at 20'-0" mounting height on steel light poles and/or equipment steel structure columns, and wired to a dedicated 120VAC or 240VAC circuit(s). With Security Lighting, personnel shall be able to observe equipment locations from outside the station fence, and such lighting shall serve as a deterrent to keep people from trespassing and/or tampering with equipment.

1.17 AC Station Service System

AC station service is extremely important to the reliable operation of substation equipment. When AEP facilities are located in Requester's substation, AEP must approve the design and construction of the AC station service system. The standard station service voltage preferred is 120/240VAC. Primary and backup station service shall be provided from two unique busses. Receptacles are needed in the substation yard adjacent to AEP equipment for various AC needs. AEP will indicate the type of receptacle needed for each location.

1.18 DC Station Service System

DC station service for a substation is needed to supply critical station loads. These station loads include circuit switchers, breakers, motor operated switches, switchgear, RTUs, relays, DC/AC inverters and communications facilities. The DC system voltage is typically obtained from a station battery and the associated charging system. The standard AEP battery voltages are 48 VDC and 125 VDC. Each substation must have a properly sized battery and charger to carry the DC station loads during an AC power failure. AEP will work with the Requester to determine proper sizing and requirements for the DC system. The DC station service system shall be no smaller than that determined by IEEE 485 calculations.

1.19 Fusing of Potential Transformers

Fuses are normally applied to the secondary circuits of potential transformers. These fuses protect the transformer against high impedance faults on the secondary circuit of the transformer. It is general practice to omit the fuses on the connections to grounded terminals of potential transformers. This practice is essential in the case of single primary bushing type potential transformers. In addition, for certain applications involving regulators or protective relays where the continuity of excitation to these devices is more important than the possibility of damage to the transformer, it is customary to omit the fuse.

1.20 Transformer Protective Devices, and other Requester Facilities

AEP no longer allows the installation of a MOAB ground switch combination on the high side of transmission/step-down transformers unless a special need or situation warrants review. All new connections must comply with the diagrams and requirements shown in Appendix B.

1.21 Fault Interrupting Devices

Fault interrupting devices are required at the point of interconnection between AEP and the Requester. It is the Requester's responsibility to protect all of their equipment and prevent faults on their system from removing AEP's facilities and/or other customers. This practice may require the Requester to install additional station facilities to establish their desired service, or to establish a looped transmission line extension at their cost. From an electrical service point of view, it is most desirable for a Requester to locate their substation facilities near an AEP transmission line or substation. It is solely AEP's discretion to allow variances to this practice.

 AMERICAN ELECTRIC POWER BOUNDLESS ENERGY™	TRANSMISSION PLANNING GUIDELINE Requirements for Connection of New Facilities or Changes to Existing Facilities Connected to the AEP Transmission System	Rev. 2	TP-0001
			Page 12 of 99

1.22 Control Cable

AEP recommends that all control cable be shielded with both ends grounded. The color codes of control cable for AC circuits shall be constructed to match Table E-1 of ICEA S-73-532, NEMA WC-57 (Black, White, Red, Green, etc.). The color code of control cable for DC circuits shall be constructed to match table E-2 of ICEA S-73-532, NEMA WC-57; (Black, Red, Blue, Orange, Yellow, Brown, Red/black/blue, black, etc.). The Requester with interconnect cables not matching these codes shall wrap each interconnect control wire with the appropriate color code tape.

1.23 Capacitors

Transmission capacitor banks in the AEP system are usually connected single ungrounded Wye, and the size will vary depending on the system needs and the switching voltage rise. AEP requires a resistive potential device connected in the neutral of the bank to sense any imbalances caused by pack failures along with a Vee-switch ahead of a capacitor switcher to provide for a visible means of disconnecting it from the circuit. Requester capacitor data shall be shared with AEP. Transmission Planning will perform studies to determine if voltage rise or harmonic conditions associated with capacitor switching are a problem. The Requester may be required to install a pre-insertion resistor/reactor to lessen the transient effects on the transmission system resulting from capacitor switching.

AEP Typical Breaker Ratings Used on the AEP System for New Construction

Item #	Voltage Class (kV)	Type	Continuous Current (Amps)	Interruptible Current (kA)	BIL (kV)
1A	15.5	Vacuum	1200	25	110
1B	15.5	Vacuum	2000	25	110
1C	15.5	Vacuum	3000	40	110
1D	15.5	Vacuum	4000	40	110
2A	38	Vacuum	1200	25	200
3A	72.5	SF6 Dead Tank	3150	40	350
4A	145	SF6 Dead Tank	3000	40	650
4B	145	SF6 Dead Tank	3150	63	650
4C	145	SF6 Dead Tank	4000	63	650
4D	145	SF6 Dead Tank	4000	80	650
5A	170	SF6 Dead Tank	3000	40	750
5B	170	SF6 Dead Tank	3000	63	750
6A	362	SF6 Dead Tank	3000	50	1300
6B	362	SF6 Dead Tank	3000	63	1300
7A	800	SF6 Dead Tank	3000	50	2050
7B	800	SF6 Dead Tank	4000	50	2050

1.24 Wavetrap, CCVT's, PT's and CT's Guidance

Wavetrap Specifications

- a) Provide with tuning pack. AEP shall define wave trap style and tuning pack requirements.
- b) Units to be factory tuned.
- c) 4-hole NEMA line terminals on both ends.
- d) Bird barriers on both ends.
- e) Corona rings required at voltages 230 kV and above.
- f) Consult with Planning Engineer for necessary ampere rating.

Coupling Capacitors with Voltage Transformers (CCVT's) Specifications

- a) Base to contain a case ground terminal.
- b) Base and metal parts to be painted with weather resistant ANSI-70 gray paint.
- c) Base and metal parts to be stainless steel or aluminum for corrosive environment.
- d) Coupling capacitor porcelain housing to be ANSI-70 gray.
- e) Top cover to be furnished with a 4-hole NEMA line terminal unless used as a support for the line trap which requires a 5" bolt circle NEMA pattern.
- f) Voltage transformer rated at 150 VA output at marked relaying ratios per ANSI C93.2.
- g) Base to contain a potential grounding switch and a 1.5" conduit nipple for potential lead exit.
- h) Two secondary windings (0.6% accuracy class) are required as a minimum. Each winding shall have at least two output voltages achieved by means of a tap. AEP may request three secondary windings (0.15% accuracy class) for metering accuracy requirements.
- i) If carrier accessories are required, the base is to contain: Drain coils, choke coil, carrier grounding switch and gap, and a carrier lead-in bushing.
- j) Line tuners are required with carrier and should be designed to pass carrier frequencies specified by AEP Protection and Control Engineering department. A separate enclosure is used to mount the line tuner; it shall be equipped with a 120 VAC heater.

Voltage/Potential Transformers (PT's) Specifications

Voltage transformers shall conform to NEMA and ANSI standards in all respects. Low voltage PT's are to be dry-type single or double bushing transformers with a minimum $\pm 0.3\%$ metering accuracy for burdens W, X, Y, and Z. High-voltage PT's are to be oil-filled transformers with a minimum $\pm 0.3\%$ metering accuracy for burdens W, X, Y, and ZZ for line-to-ground connections, and will include the following:

- a) Base and metal parts to be painted with weather resistant ANSI-70 gray paint.
- b) Base and metal parts to be stainless steel or aluminum for corrosive environment.
- c) Top cover to be furnished with a 4-hole NEMA terminal.
- d) Base shall be equipped to accommodate a minimum of two (2) conduit entrances. Two secondary windings are required when PT will be shared with IED other than meters. Each winding shall have at least two output voltages achieved by means of a tap.

Current Transformers (CT's) Specifications

The current transformers shall conform to NEMA and ANSI standards in all respects. Low voltage CT's can be window or terminal type with a minimum metering accuracy class of $\pm 0.3\%$ at specified burden ratings. Relay class may be used if revenue meters are not needed. Current transformers should have the required accuracy rating at the operational connection for which it will be used without creating a thermal

 AMERICAN ELECTRIC POWER BOUNDLESS ENERGY™	<u>TRANSMISSION PLANNING GUIDELINE</u> Requirements for Connection of New Facilities or Changes to Existing Facilities Connected to the AEP Transmission System	Rev. 2	TP-0001
			Page 14 of 99

limitation in the connected circuit. High Voltage CT's shall be outdoor type, freestanding, oil or SF6 filled and shall include the following:

- a) Base and metal parts to be painted with weather resistant ANSI-70 gray paint.
- b) Base and metal parts to be stainless steel or aluminum for corrosive environment.
- c) Base shall be equipped to accommodate a minimum of two (2) conduit entrances.
- d) d. Manufacturer shall provide a ground point for grounding the case.
- e) Bushing shall be one-piece porcelain and ANSI-70 gray.
- f) Bushings shall meet ANSI standards for the type and class required.
- g) If oil filled, oil to be certified non-PCB.
- h) h. If oil filled, CT's shall have a visual indication of oil level.
- i) If gas filled, CT's shall have approved gas density mounting devices for visual indication of the gas density which can be read from ground.

1.25 Insulation

Equipment utilized in substations (where AEP facilities are installed) shall comply with the following BIL standard:

Description	Basic Lightning Impulse Insulation Level (BIL) (kV rms) at System kV listed below			
	12.47	13.8	25	34.5
2Wdg Xfmr Internal BIL	110	110	150	200
2Wdg Xfmr Bushing BIL	110	110	150	200
Bus/Switch Support BIL	110	110	150	200
Circuit Breaker Bushing BIL	110	110	150	200
Auto Xfmr Internal BIL	110	110	150	200
Auto Xfmr Bushing BIL	110	110	150	200

Description	Basic Lightning Impulse Insulation Level (BIL) (kV rms) at System kV listed below					
	69	115	138	161	230	345
2Wdg Xfmr Internal BIL	350	550	550	650	750	1050
2Wdg Xfmr Bushing BIL	350	650	650	750	900	1300
Bus/Switch Support BIL	350	550	550	650	900	1300
Circuit Breaker Bushing BIL	350	650	650	750	900	1300
Auto Xfmr Internal BIL	350	550	550	650	750	1050
Auto Xfmr Bushing BIL	350	650	650	750	900	1300

In areas classified as “Corrosive Environments,” insulators and bushings will be supplied with high creep skirts. The BIL rating of the insulator need not be increased, but the total creepage must meet the following requirements:

Equipment Voltage Rating (kV)	BIL (kV)	Minimum External Creepage Distance (inch)	
		AEP Creepage Required	ANSI C37.01.06 (Reference Only)
15.5	110	17	9
25.8	150	26.5	15
38	200	-	22
72.5	350	72	42
121	550	-	70
145	650	133	84
169	750	-	93
242	900	-	140
362	1300	318	209

1.26 Metering Requirements

The metering requirements apply to all new AEP and GC, TI or EUC Requester facilities. Existing facilities and like-in-kind replacements of existing facilities are exempt from these requirements and are covered by existing agreements. However, any modification, addition or upgrade to facilities and equipment necessary to physically and electrically connect to the AEP transmission system shall require that associated metering systems be reviewed and brought into compliance with AEP's current metering standards.

At least N-1 metering elements will be used to measure all real and reactive power at the point of interconnection for each metering point, where N is the number of wires in service including the ground wire.

For all transmission interconnections, a transfer of power between AEP and the GC, TI, or EUC Requester’s system shall be metered at the point of interconnection.

For a GC, TI and EUC Requester having more than one point of interconnection (e.g. two or more lines), independent metering is required at each point of interconnection.

The power transfer between AEP and the GC, TI, or EUC Requester shall be metered with AEP-approved energy meters with bi-directional measurement capability. AEP-approved energy meters shall have the capability to meter instantaneous bi-directional real (kW) and reactive (kVAR) power and real (kWh) and reactive (kVARh) energy.

Real power flow from AEP to the GC, TI, or EUC Requester is designated as kWh “Out” or kWh “Delivered.” kWh “Out” or “Delivered” is considered positive. Real power flow from the GC, TI, or EUC Requester to AEP is designated as kWh “In” or kWh “Received.” kWh “In” or “Received” is considered negative. The same conventions shall be observed for reactive or kVAR power. Each of the four quantities shall be recorded separately. The energy meter recorder channel assignments and recording interval of the GC, TI, or EUC Requester’s energy usage for the billing period will be determined by AEP. AEP reserves the right to specify the type and manufacturer for all metering equipment including the instrument transformers. Metering quantities reconciling the power flow and energy usage for the settlement of the interconnected facilities available to AEP and the GC, TI, or EUC Requester will originate from the primary meter of record for each metered circuit. If requested, backup metering can be provided to the GC, TI, or EUC Requester.

All metering quantities shall be measured at, or at AEP’s option, compensated to, the point of interconnection.

The metering equipment facility shall accommodate 24 hour per day accessibility by AEP personnel without escort from GC, TI or EUC Requester, facility operator, or landowners. If requested, AEP will develop an Interconnection Point List with available Analog, Status, and Accumulator points and submit to the GC, TI, or EUC. AEP will configure one RTU communications port using the points agreed upon in the Interconnection Point List in DNP3 format. If such metering quantities are not available from AEP RTU equipment, they may be available by alternate means at the GC, TI, or EUC Requester's expense.

Costs for any changes and/or upgrades to AEP-specified metering equipment required to meet AEP metering standards shall be borne by the GC, TI, or EUC Requester. Dial-up telephone lines paid for and provided by AEP serve primarily to facilitate AEP and/or RTO/ISO remote access to meters for interrogation. Limited access (including time of use and call duration) to an AEP meter interrogation telephone line is extended to the GC, IT, and EUC Requester solely at AEP's discretion without assurance of compatibility with Requester's equipment. AEP will make a reasonable attempt to assist the Requester with remote interrogation over such telephone line (for example, provide dial-up information, settings, and initial troubleshooting). AEP is not responsible for providing readings to the GC, TI, and EUC Requester should the Requester be unsuccessful interrogating the meter on an ongoing basis. If the Requester is not satisfied with the quality or conditions of using AEP's dial-up telephone line, an alternative communication path, subject to AEP approval, at Requester's expense, can be considered to facilitate remote access to the meter. Troubleshooting such alternative communication path is the responsibility of the Requester; AEP will assist with necessary maintenance at Requester's expense.

Interconnection metering voltage transformers (VT's) and current transformers (CT's) shall be revenue class and at a minimum shall meet the latest ANSI C57.13 requirements for instrument transformers. AEP reserves the right to specify additional requirements for metering VT's and CT's.

For generation interconnection metering, "In" / "Out" power flow is referenced from AEP or the control grid's perspective. Real power MW generation will be designated as MW "In" or MW "Received." MW "In" or "Received" is considered negative from AEP or the control grid's perspective. Backfeed or startup power from AEP to the GC Requester is MW "Out" or MW "Delivered" and is considered positive from AEP or control grid's perspective. The same conventions will be observed for reactive or MVAR power.

For those locations where it may be possible to switch the generation between RTOs/ISOs, there may be unique requirements for metering. AEP shall determine the metering requirements on a site-specific basis.

For additional information reference Appendix E (AEP Metering Requirements for Transmission Interconnection Facilities – verification of latest revision required).

1.27 SCADA Requirements

Status, analog, and hourly accumulation points, as specified by AEP, shall be supplied by the GC, TI and EUC Requester for each point of interconnection and connected to the transmission-specific remote terminal unit (RTU) used for the point of interconnection.

For GC Requesters where the total plant generation capacity is equal to or greater than 50 MVA, a generation-specific remote terminal unit (RTU) is required for AEP's generation-specific Supervisory Control and Data Acquisition (SCADA).

For locations where AEP requires supervisory control: if the interconnect is a generator, the trip must be hardwired to the trip coil (not through a relay) per AEP's current hardwire rules. If the interconnect is only a Transmission load, the trip/close can be wired to a non-AEP relay using DNP, or hardwired to the trip/close coils. If using DNP for Trip/Close, please Object 12, Variance 1 (which defines control relay output block), and specify the SEL control function is paired (with one DNP Index) or unpaired (with two DNP indexes). Inputs to the RTU shall be supplied by an AEP-approved interface device unless otherwise specified as hardwired. Any interface device, that AEP will poll, will be individually polled by the RTU: interface devices polled by the RTU will not be daisy chained. Each IED or interface device to be directly polled by the RTU via DNP 3.0. The type of hardware signal at the ownership boundary used to interface the RTU shall be either: "RS-485" (use for metallic RS-485 cable), "MM RS-232" (use for multi-mode optical cable terminated in fiber-to-RS-232 converter at the RTU), "SM RS-232" (use for single-mode optical cable

 AMERICAN ELECTRIC POWER BOUNDLESS ENERGY™	TRANSMISSION PLANNING GUIDELINE Requirements for Connection of New Facilities or Changes to Existing Facilities Connected to the AEP Transmission System	Rev. 2	TP-0001
			Page 17 of 99

terminated in a fiber-to-RS-232 converter at the RTU), and “AEP’s SEL-2411 Wetting Voltage 125 VDC.” All Supervisory Control and Data Acquisition (SCADA) equipment shall be subject to approval by AEP.

For those locations where it may be possible to switch the generation between RTOs/ISOs, there will be unique requirements for SCADA; such requirements will be determined by AEP on a project-specific basis. A specific RTU points list will be developed by AEP as a part of each transmission project based upon the project's electrical configuration. For such purpose the GC, TI and EUC Requester shall responsible for providing AEP with metering and relaying one-line diagrams and communication network schematics of the transmission and substation facilities. For additional information reference Appendix F (AEP SCADA RTU Requirements for Transmission Interconnection Facilities verification of latest revision required).

1.28 RTU Requirements

A transmission-specific remote terminal unit (RTU) is required for all transmission interconnections. In addition, a generation-specific RTU may be required for AEP’s generation-specific Supervisory Control and Data Acquisition (SCADA); for more information reference Generation SCADA Requirements in Appendix F. The GC, TI and EUC Requester’s facility design and operations shall accommodate 24 hour per day accessibility to each AEP RTU by AEP personnel without escort from GC, TI or EUC Requester, facility operator or landowners. The GC, TI and EUC Requester shall marshal all their RS-485 and hardwired RTU inputs at a marshaling cabinet (interface terminal block or interface cabinet) satisfactory to AEP. The GC, TI and EUC Requester shall engineer, procure, construct and own the marshaling cabinet, wire to the marshaling cabinet from the various generation or substation equipment, provide AEP with documentation identifying the location of generation or substation SCADA points wired to the marshaling cabinet, and provide AEP with terminals at the marshaling cabinet from which to wire to each RTU. The GC, TI and EUC Requester shall provide a dedicated station DC breaker for each RTU located at the GC, TI or EUC Requester’s facilities.

Prior to AEP placing the interconnection facility in service, the transmission-specific RTU and the generation-specific RTU described here shall be operational with AEP-required RTU functions commissioned by AEP. For additional information reference Appendix F (AEP SCADA RTU Requirements for Transmission Interconnection Facilities – verification of latest revision required)

1.29 Circuit Requirements

GC, TI and EUC Requesters shall be responsible for procuring and paying for communication circuits for use by AEP. The GC, TI and EUC Requester shall be responsible for confirming with AEP the project-specific circuit requirements and requesting specific AEP addresses and AEP contact names in preparation for issuing communication circuit orders with the GC, TI or EUC Requester's telecommunication service provider of choice. These communication circuits shall be leased telephone company circuits satisfactory to AEP. For each telephone company circuit leased by the GC, TI and EUC Requester, the GC, TI and EUC Requester shall provide AEP and the telecommunication service provider with advanced authorization for communication circuit maintenance, allowing AEP and any of its affiliates and subsidiaries to monitor the circuit, report trouble and take corrective action with the telecommunication service provider, at the GC, TI or EUC Requester's expense, to maintain circuit reliability. Voice communications satisfactory to AEP shall be installed and maintained by Requester per requirements of the RTO/ISO, operating company, transmission company, or applicable agreement. Backup communication circuits may be required per terms of an agreement. The communication circuits described here shall be operational and commissioned by AEP prior to AEP placing the interconnection facility in service. Typical facility circuit requirements include the following:

- a) RTU Communications Circuit - This is a leased circuit from the demark associated with the RTU at the GC, TI or EUC Requester's facility to an AEP Dispatch office; this circuit is to be ordered and paid for by the GC, TI or EUC Requester. One circuit is required for each RTU. This circuit will be utilized by AEP to communicate with the RTU and, if applicable, the station data repository. The required RTU Communications Circuit is a 56 Kbps digital circuit with DDS interface at the RTU end and DDS interface at the AEP Dispatch office end (or another circuit as specified by AEP).

Voice Dispatch Circuit - This is a leased circuit from the GC Requester's facility plant operators to an AEP Dispatch office. If the GC Requester's facility plant operators are not located on the plant site, then the circuit must be terminated at the actual location of the plant operators. This dedicated circuit is required of the GC Requester where the total plant generation capacity is equal to or greater than 50 MVA. This circuit is to be ordered and paid for by the GC Requester. The TI and EUC Requester may be required to order and pay for a dedicated Voice Dispatch Circuit per terms of an agreement.

- b) Dial-Up Circuit - This is a standard business telephone line (with a 10-digit telephone number, also known as a POTS line) with long distance provisioning to be ordered and paid for by the GC, TI or EUC Requester. The Dial-Up Circuit provides a connection to the public telephone network. The requirement for one or more Dial-Up Circuits will be determined by AEP on a project-specific basis. This circuit may be required for voice communications and interconnect meter reading. If interconnect meters are located at multiple sites, then multiple Dial-Up Circuits may be required. If multiple meters are located at the same site, one Dial-Up Circuit may suffice for dial-up access. (In this case, the GC, TI or EUC Requester is to receive approval from AEP prior to installing a telephone switch to share one Dial-Up Circuit among multiple meters.)

1.30 Demark Requirements

For all telephone company circuits leased to a GC, TI or EUC Requester-owned substation, demarcation equipment (demark or telephone company interface box) satisfactory to AEP shall be installed, owned and maintained by the substation owner. The demark shall house all telephone company circuit termination equipment at the substation, including, but not limited to, the network interface. The demark shall provide the interface between the telephone company's service cable and the substation. The substation owner shall provide 120 VAC power to the demark sourced from an appropriately sized DC/AC inverter in the substation control building. The DC/AC inverter shall be powered from a dedicated substation DC breaker sourced from a minimum 8-hour substation battery. The demark shall be located on the substation ground grid and accessible outside the substation fence or through a secured personnel gate or door. The substation owner shall install, own and maintain communications cable with surge protection satisfactory to AEP between the demark and the substation control building. Telephone company personnel shall have no access to the control building housing an AEP RTU. The demark design shall accommodate 24 hour per day accessibility by AEP personnel without escort from telephone company personnel, GC, TI or EUC Requester, facility operator or landowners. The demark design shall accommodate 24 hour per day accessibility by telephone company personnel without escort from AEP personnel, GC, TI or EUC Requester, facility operator or landowners. Prior to construction of the demark, GC, TI and EUC Requester is to submit its design to AEP for review and approval; such design is to include physical locations of the telephone company's service cable, substation ground grid, demark mounting structure, substation fence and substation control building. The demark described here shall be operational and commissioned by AEP prior to AEP placing the interconnection facility in service.

1.31 High Voltage Isolation Requirements

High voltage isolation (HVI) facilities at the GC, TI or EUC Requester-owned substation satisfactory to AEP shall be installed and maintained as described below. Such HVI facilities shall include either telephone company-owned all-dielectric fiber optic service cable installed to the demark through the ground potential rise (GPR) high voltage zone of influence, or HVI equipment installed at the demark for all telephone company circuits carried on copper cable. Prior to construction of the HVI, the GC, TI and EUC Requester is to submit its design to AEP for review and approval; such design is to include physical locations of the telephone company's service cable, substation ground grid, demark mounting structure, HVI facilities, substation fence and substation control building.

Option 1 All-dielectric fiber optic service cable - GC, TI and EUC Requester will cause the telephone company to install, own and maintain all-dielectric fiber optic service cable to the demark located on the GC, TI or EUC Requester's substation ground grid. Armored fiber optic

 AMERICAN ELECTRIC POWER BOUNDLESS ENERGY™	TRANSMISSION PLANNING GUIDELINE Requirements for Connection of New Facilities or Changes to Existing Facilities Connected to the AEP Transmission System	Rev. 2	TP-0001
			Page 19 of 99

CAUTION: Printed copies of this document are uncontrolled and may be obsolete.
Always check for the latest revision prior to use.

cable shall not be installed within the GPR high voltage zone of influence. Armored fiber optic cable shall be transitioned to all-dielectric fiber optic cable by the telephone company outside the GPR high voltage zone of influence. This all-dielectric fiber optic service cable is to extend from a location at or beyond the 300 volt point, through the GPR high voltage zone of influence, to the demark. The all-dielectric fiber optic service cable design (no metallic members such as protective armor sheath or trace wire) and its installation (no metallic members such as metal conduit, power cable or wire) shall be satisfactory to AEP. The all-dielectric fiber optic service design shall accommodate 24 hour per day accessibility by telephone company personnel without escort from AEP personnel, GC, TI or EUC Requester, facility operator or landowners.

Option 2 HVI equipment for copper cable - HVI equipment for all telephone company circuits carried on copper cable to GC, TI or EUC Requester's substation demark shall be installed and maintained by the substation owner. The HVI equipment shall be designed to adequately protect against GPR and shall be satisfactory to AEP and the telephone company. The HVI equipment shall be located on the substation ground grid and accessible outside the substation fence or through a secured personnel gate or door. The HVI equipment shall be located on the central office (telephone company) side of the demark. The HVI equipment design shall accommodate 24 hour per day accessibility by AEP personnel without escort from telephone company personnel, GC, TI or EUC Requester, facility operator or landowners. The HVI equipment design shall accommodate 24 hour per day accessibility by telephone company personnel without escort from AEP personnel, GC, TI or EUC Requester, facility operator or landowners.

The HVI facilities described above shall be operational and commissioned by AEP prior to AEP placing the interconnection facility in service.

1.32 Access Plan Requirements

GC, TI and EUC Requester shall provide an access plan to AEP for review and approval. Such access plan is to document AEP and telephone company personnel access privileges and restrictions to interconnection facilities on GC, TI and EUC Requester property, including, but not limited to, the remote terminal unit (RTU), station data repository, metering equipment, telephone company interface box (demarcation equipment), high voltage isolation equipment and fiber optic equipment.

The access plan described above shall be approved by AEP prior to AEP placing the interconnection facility in service.

1.33 Fiber Optic Cable Requirements

If the GC, TI and EUC Requester's interconnection facilities include fiber optic cable, including, but not limited to, optical ground wire (OPGW), all-dielectric self-supporting (ADSS) cable and underground fiber optic cable, it shall be installed by GC, TI and EUC Requester in accordance with AEP specifications. GC, TI and EUC Requester shall, at its cost, engineer, furnish, and install at its substation an all-dielectric fiber optic station entrance cable system to ensure that no fiber optic cable with metallic members is extended into the substation control building. Fiber optic cable with metallic members includes, but is not limited to, OPGW, fiber optic cable with an integral trace wire, and metallic-armored fiber optic cable. The all-dielectric fiber optic station entrance cable system shall include all-dielectric fiber optic station entrance cable, the outdoor splice case, trays and fusion splice sleeves for the fiber optic cable to station entrance cable transition, the indoor splice housing, trays and fusion splice sleeves, fiber pigtails and the control building fiber distribution panel (FDP). If the interconnection facilities include fiber optic cable that contains no metallic members, it may be extended into the substation control building without transitioning to the all-dielectric fiber optic station entrance cable noted above. GC, TI and EUC Requester shall, at its cost, at its substation, perform splicing of all fibers in the transition splice and the FDP. AEP shall, at GC, TI or EUC Requester's expense, engineer, furnish, and install at AEP's substation the all-dielectric fiber optic station entrance cable system to be owned by the GC, TI or EUC Requester, and shall perform splicing of all fibers in the transition splice and the FDP. GC, TI and EUC Requester shall grant to AEP, at no cost to

 AMERICAN ELECTRIC POWER BOUNDLESS ENERGY™	TRANSMISSION PLANNING GUIDELINE Requirements for Connection of New Facilities or Changes to Existing Facilities Connected to the AEP Transmission System	Rev. 2	TP-0001
			Page 20 of 99

AEP and for so long as the interconnection agreement remains in effect, an indefeasible right to use the last 24 fibers in the fiber optic cable. GC, TI and EUC Requester, at its sole expense, will maintain in operating condition such fiber optic cable and associated station entrance cable systems at the GC, TI or EUC Requester and AEP substations.

In addition, GC, TI and EUC Requester shall grant to AEP the following rights:

- 1) The right to co-locate fiber optic equipment in GC, TI or EUC Requester's substation;
- 2) Access to and use of all AEP-assigned fibers - FDP to FDP;
- 3) Access to and use of all route splice points, with the right to cross-connect AEP-assigned fibers for through circuits - FDP to FDP, and equipment to FDP;
- 4) Control building rack space for communications equipment;
- 5) Dedicated substation DC breakers and cables sourced from a minimum 8-hour substation battery;
- 6) Dedicated substation 120 VAC breakers and cables upon request; and
- 7) Access to GC, TI or EUC Requester's substation for the installation and management of fiber jumpers and electronics.

Unless otherwise agreed or otherwise specified in the interconnection agreement, each party will be responsible for maintenance and repair of its facilities and equipment.

Upon GC, TI or EUC Requester's request and AEP acceptance, AEP will, at GC, TI or EUC Requester's expense, provide maintenance and repair including replacement, if needed, of the station entrance cable systems at the GC, TI or EUC Requester and AEP substations.

1.34 All-Dielectric Fiber Optic Cable Requirements

Fiber optic cable with metallic members shall not be terminated in or routed through the GC, TI or EUC Requester's substation control building, the telephone company interface box (demarcation equipment), or the substation's high voltage isolation enclosure. Fiber optic cable with metallic members includes, but is not limited to, optical ground wire (OPGW), fiber optic cable with an integral trace wire, and metallic-armored fiber optic cable. Fiber optic cable with metallic members shall be transitioned to all-dielectric fiber optic cable, satisfactory to AEP, prior to the fiber entering the substation control building, the telephone company interface box, or the substation's high voltage isolation enclosure. The all-dielectric fiber optic cable design (no metallic members such as protective armor sheath or trace wire), the all-dielectric fiber optic cable installation (no metallic members such as metal conduit, power cable or wire) and the transition splice shall be satisfactory to AEP.

 AMERICAN ELECTRIC POWER BOUNDLESS ENERGY™	TRANSMISSION PLANNING GUIDELINE Requirements for Connection of New Facilities or Changes to Existing Facilities Connected to the AEP Transmission System	Rev. 2	TP-0001
			Page 21 of 99

2.0 GENERATOR CONNECTION (GC) FACILITIES - CONNECTION REQUIREMENTS

This section describes the requirements of new or modified generation facilities connecting to a transmission line or substation owned by AEP Operating Companies or Transmission Companies. These requirements apply to all Requesters that operate their generation in parallel with the AEP transmission system.

Requesters that will parallel their “backup generation” with AEP for 100 ms or less (for the purposes of “closed transition switching” and load testing of units) could be considered a separate connection. The Requester shall consult with AEP’s Transmission Planning department to receive guidance and approval from AEP regarding safe and reliable operation. All switching of the Requester’s load and backup generation shall be coordinated with local AEP Transmission Operations.

One purpose of these requirements is to ensure compliance with two Federal Energy Regulatory Commission (FERC) rules regarding standards that the utility and the Requester must follow in the course of connecting a generator to the transmission system:

- 1) Standardization of Generator Interconnection Agreements and Procedures adopted by FERC on August 19, 2003 in FERC Order No. 2003. These final rules require public utilities that offer transmission service, which includes the AEP operating companies and transmission companies, to use standardized generation interconnection procedures and agreements for all pending or new requests to interconnect generators larger than 20 MW at transmission voltage. The latest issue of Order No. 2003 can be referenced on the FERC website:
<http://www.ferc.gov/industries/electric/indus-act/gi/stnd-gen.asp>
- 2) Standardization of Small Generation Interconnection Agreements and Procedures adopted by FERC on May 12, 2006 in FERC Order No. 2006. These final rules require public utilities that offer transmission service, which includes the AEP operating companies and transmission companies, to use standardized generation interconnection procedures and agreements for all pending or new requests to interconnect a generator that is 20 MW or less at transmission voltage. The latest issue of Order No. 2006 can be referenced on the FERC website:
<http://www.ferc.gov/industries/electric/indus-act/gi/small-gen.asp>

These FERC Final Rules establish pro forma generation interconnection procedures that provide a universal set of requirements for all AEP transmission systems.

2.1 Generator Connection Options

The physical connection of a generation facility to the AEP transmission system can be one of two types: station or line. The connection type(s) will be dependent on the Requester’s location within the AEP transmission system.

If the facility is located sufficiently close to an AEP station, it may be directly connected to that station by one or more lines, with each line terminated by one or more circuit breakers. System protection and control requires optical fiber communication cable between the Requester’s facilities and the AEP station if hardwiring is not practical. The Requester will own the breaker(s), protection and control for all equipment located within their facilities. The Requester is responsible for the synchronization of their facilities with the transmission system and protection of its facilities from all abnormal conditions occurring on the transmission system.

If the generation facility is located closer to a transmission line (or lines) than to a station, the connection could be established by extending the line(s) into a new switching station. The ownership and control of new customer-built switching stations must be transferred to AEP upon completion and the stations must meet all applicable AEP design standards. The switching configuration of all circuits terminating at the switching station must provide an AEP through-path when the generation facility, or associated switching station equipment, is out of service. The configuration of a new switching station will be specific to the project and its location within the transmission system. System protection and control requires optical fiber communication cable between the Requester’s facilities and the AEP station if hardwiring is not practical. The Requester is responsible for protection of its facilities from all abnormal conditions occurring on the transmission system. The Requester is responsible for synchronizing their facilities with the transmission system.

 AMERICAN ELECTRIC POWER BOUNDLESS ENERGY™	TRANSMISSION PLANNING GUIDELINE Requirements for Connection of New Facilities or Changes to Existing Facilities Connected to the AEP Transmission System	Rev. 2	TP-0001
			Page 22 of 99

Typical simplified station configurations are illustrated in Appendix B.

The Requester may elect to operate the generation facilities in parallel with AEP, or as a separate system with the ability of non-parallel load transfer between two independent systems. The requirements for these two methods of operation are outlined as follows:

2.1.1 Parallel Connection

It is the practice of AEP to permit any qualifying generator to operate its generating equipment in parallel with the AEP electric system, provided this connection can be accomplished without adverse effects on the general public, AEP equipment or other customers.

A parallel system is defined as one in which the generation is connected to a bus common with the utility's system. A transfer of power between the two systems is a direct and often desired result. A consequence of such parallel operation is that the parallel generator becomes an electrical part of the utility system, which must be considered in the electrical protection of the utility's facilities.

AEP transmission lines are subject to a variety of natural and man-made hazards such as lightning, wind, animals, automobiles, and malicious acts. Electrical problems resulting from these hazards include short circuits, grounded conductors, and broken conductors. These fault conditions require that the damaged equipment be de-energized as soon as possible due to the potential hazards they pose to the public and the operation of the system. Another potential consequence of these hazards is "accidental isolation." This condition could occur when a portion of the system load becomes isolated from the utility source, but is still connected to the Requester's parallel generation. The parallel generator connected to an "isolated" portion of the system represents another source of power to energize the lines should system outage(s) occur. The isolated system with parallel generation may continue to operate independent of the utility with abnormal voltage or frequency.

Protective devices and other requirements are necessary for AEP to provide a defense against the hazards noted above by disconnecting the parallel generator when trouble occurs. The devices specified by AEP must be installed at the location where the Requester will operate parallel generation. Additional modifications to the existing electrical or protective system configuration may be required in order to accommodate a parallel generation connection.

In addition to the installation of specified protective devices, a parallel Requester must install and maintain equipment to monitor and verify the proper interconnected operation (both transient and steady state) for expected power system disturbances. The Requester shall also set generator-operating parameters to enhance power system security as specified in the later sections of these interconnection requirements. The Requester is responsible to comply with all applicable NERC reliability standards.

AEP assumes no responsibility for protection of the Requester's generator(s), nor of any other portion of the Requester's electrical equipment for any or all operating conditions. The Requester is fully responsible for protecting the Requester's equipment from faults or other disturbances originating on the AEP system or any other system interconnected with the AEP system.

The Requester may not commence parallel operation of generator(s) until consent has been granted by AEP. AEP reserves the right to inspect Requester's facility and witness the testing of equipment or devices associated with the interconnection. Operating Procedures related to start-up, connection, disconnection and safety may be included in the Interconnection Agreement.

2.1.2 Separate Connection

With a separate generation connection, there is no possibility of connecting the Requester's generating equipment to the bulk electrical system. For this type of connection to be practical, the Requester's load must be capable of transition between the two systems in an open or non-

	<p style="text-align: center;"><u>TRANSMISSION PLANNING GUIDELINE</u> Requirements for Connection of New Facilities or Changes to Existing Facilities Connected to the AEP Transmission System</p>	Rev. 2	TP-0001
			Page 23 of 99

CAUTION: Printed copies of this document are uncontrolled and may be obsolete.
Always check for the latest revision prior to use.

parallel mode. This could be accomplished by either an electrically or mechanically interlocked switching arrangement that precludes operation of both switches in the closed position.

If the Requester has a separate system, AEP will require verification that the transfer scheme meets the non-parallel requirement. Verification of this switching ability may be accomplished by review of drawings by AEP, Requester's notification in writing to AEP, or by field inspection of the transfer scheme. AEP will not be responsible for reviewing, approving or evaluating the customer's generation equipment and assumes no responsibility for its design or operation.

Most Uninterruptible Power Supply (UPS) systems do not specifically meet the separate system criteria. However, if a UPS system is not capable of back feed (transfer of electric power from the emergency source to the normal source), it will be classified as a separate system. If it can back feed, it must meet the requirements of parallel generation.

2.2 Information Required from Generator Connection Requester

The Requester must provide comprehensive facility data for the mandatory analytical studies. The data will be used to assess the system performance of the generation facility which includes, but is not limited to, steady state, short circuit and transient stability performance. The data are also needed to develop project cost estimates. Below is an example of information that the Requester may be asked to submit to AEP and/or the RTO/ISO.

Once the facility has been declared ready for operation, AEP shall receive final generation facility documentation that will replace the specifications and data submitted for the earlier design review.

Three months prior to energization of the generation facility the following information will be required:

1. Transmission line length, rating, positive- and zero-sequence impedances based on **final** transmission line design
2. Final collector station relay one-line
3. Final collector station relay (excluding inter-connect transmission line relays) settings, such that both parties must agree that coordination has been achieved before energization. Redundant high speed protection schemes for generation facilities may be required to achieve coordination with Transmission protection schemes.

Note; if line relays obtained by developer differ from relays previously approved by AEP, **back-feed will be delayed until previously approved relays are obtained and made available for developer's line terminal,**

Prior to the operation of a generation facility, the Requester shall supply to AEP three copies of all final electrical one-line diagrams, equipment data, and schematic diagrams. Subsequent revisions affecting the generation shall be documented with three copies of the revised electrical one-line and schematic diagrams.

 AMERICAN ELECTRIC POWER <small>BOUNDLESS ENERGY™</small>	TRANSMISSION PLANNING GUIDELINE Requirements for Connection of New Facilities or Changes to Existing Facilities Connected to the AEP Transmission System	Rev. 2	TP-0001
			Page 24 of 99

Information Supplied By Generator Connection Requester

RTO/ISO Generator Interconnection Queue # _____ Date: _____

Name, address, telephone number, and Email address of **Generator Connection Requester**:

Name: _____ Title: _____

Company: _____ Phone: _____

Address: _____ Email: _____

Name of Project Manager's "**Single Point of Contact**" - individual with authority (equal to Generator Connection Requester) to make day-to-day decisions regarding the processing of the Interconnection Request:

Name: _____ Title: _____

Company: _____ Phone: _____

Address: _____ Email: _____

Name, address, telephone number, and Email address of individual(s) representing the Generation Owner related to technical questions about the design and operation of the proposed Facility:

Name: _____ Title: _____

Company: _____ Phone: _____

Address: _____ Email: _____

1. Site Plan (on tax map, USGS Topography map, etc.) for Interconnection Customer's Facilities (electronic file if available).
Note: AEP has specific guidelines for site selection and must approve the interconnection substation location and design.
2. Interconnection Customer's proposed location (if known) for Point of Interconnection (POI) to AEP system.
3. Type of generator (Synchronous, Induction, Inverter, etc.), and rating of proposed generator(s).
4. Project Schedule.
5. Back feed Requirement and Date.
6. Generation Testing (1st energy into grid) Dates.
7. Expected Commercial Dates.
8. Confirm/acknowledge Queue MWs (at 92°F ambient) and choice of Capacity or Energy-Only rights.
9. Fuel type (gas, wind, nuclear, diesel, etc.) and technology (steam turbine-generator, combustion turbine-generator, combined / simple cycle, etc.) for generation.
10. Unit capability data (presented below).
11. Unit dynamics data (presented below).
12. If customer's facilities are presently connected to the AEP system, provide a one-line diagram of existing connection arrangement with existing meter locations identified. Identify meter type (e.g., kWh revenue).

The Generator Connection Requester shall provide the following:

1. One-line diagram of Facility electrical arrangement.
2. All potential elementary drawings associated with the protection and control schemes for the generator and interconnection equipment.
3. All current elementary drawings associated with the protection and control schemes for the generator and interconnection equipment.

 AMERICAN ELECTRIC POWER BOUNDLESS ENERGY™	<u>TRANSMISSION PLANNING GUIDELINE</u> Requirements for Connection of New Facilities or Changes to Existing Facilities Connected to the AEP Transmission System	Rev. 2	TP-0001
			Page 25 of 99

4. A control elementary of the generator breaker and the interconnection breaker.
5. A three-line diagram of generation system.
6. Documentation of all protective device settings to include relay type, model/catalog number and setting range. If automatic transfer schemes or unique or special protective schemes are used, a description of their operation should be included. AEP must review and approve the settings of all protective devices and automatic control equipment which: (1) Serve to protect the AEP power delivery system from hazardous currents and voltages originating from the facility, or (2) Must coordinate with protective devices or control equipment located on the AEP power delivery system.
7. Modeling data must be supplied to AEP and/or the RTO/ISO to allow necessary interconnection studies to be performed. It is recognized that some of this data may initially be preliminary in nature. Interconnection studies will be based on data submitted. Changes or modifications to this data after the interconnection study has been completed may render the analysis invalid and require re-opening of the interconnection study. It is the Generator Connection Requesters responsibility to make AEP and / or the RTO/ISO aware of changes to this data, and to provide final certified test reports and modeling data as soon as it is available.

The One-Line Diagram and Three-Line Diagram shall include the following information:

1. Equipment names and/or numerical designations for all circuit breakers, contactors, air switches, transformers, generators, etc., associated with the generation as required by AEP to facilitate switching.
2. Power Transformers – name or designation, nominal kVA, nominal primary, secondary, tertiary voltages, vector diagram showing winding connections, tap setting and transformer impedance. A copy of the transformer nameplate and test report that includes both positive and zero sequence impedance information will ultimately be required.
3. Station Service Transformers – Designate phase(s) connected to and estimated kVA load.
4. Instrument Transformers – Voltage and current, phase connections.
5. Surge Arresters/Gas Tubes/Metal Oxide Varistors/Avalanche Diode/Spill Gaps/Surge Capacitors, etc. – Type and Ratings.
6. Capacitor Banks – kVAR rating.
7. Disconnect Switches – Indicate status normally open with a (N.O.) and whether manual or motor operated. Include switch voltage, continuous and interrupting ratings.
8. Circuit Breakers and/or Contactors – Interrupting rating, continuous rating, operating times.
9. Generators(s) – Include nameplate, test report, type, connection, kVA, voltage, current, rpm, PF, impedances, time constants, etc.
10. Point of Interconnection to power delivery system and phase identification.
11. Fuses – Manufacturer, type, size, speed, and location.

Elementary Diagrams shall include the following information:

1. Terminal designation of all devices – relay coils and contacts, switches, transducers, etc.
2. Relay functional designation – per latest ANSI standard. The same functional designation shall be used on all drawings showing the relay.
3. Complete relay type (such as CV-2, SEL321-1, REL-301, IJS51A, etc.).
4. Switch contact shall be referenced to the switch development if development is shown on a separate drawing.
5. Switch developments and escutcheons shall be shown on the drawing where the majority of contacts are used. Where contacts of a switch are used on a separate drawing, that drawing should be referenced adjacent to the contacts in the switch development. Any contacts not used should be referenced as spare.
6. All switch contacts are to be shown open with each labeled to indicate the positions in which the contact will be closed. Explanatory notes defining switch coordination and adjustment where mis-adjustment could result in equipment failure or safety hazard.
7. Auxiliary relay contacts shall be referenced to the coil location drawing if coil is shown on a separate drawing. All contacts of auxiliary relays should be shown and the appropriate drawing referenced adjacent to the respective contacts.
8. Device auxiliary switches (circuit breakers, contactor) should be referenced to the drawing where they are used.
9. Any interlocks (electromechanical, key, etc.) associated with the generation or interconnection substation.

 <p>AMERICAN ELECTRIC POWER BOUNDLESS ENERGY™</p>	<p style="text-align: center;"><u>TRANSMISSION PLANNING GUIDELINE</u> Requirements for Connection of New Facilities or Changes to Existing Facilities Connected to the AEP Transmission System</p>	Rev. 2	TP-0001
			Page 26 of 99

10. Ranges of all timers and setting if dictated by control logic.
11. All target ratings; on dual ratings note the appropriate target tap setting.
12. Complete internal for electromechanical protective relays. Microprocessor type relays may be shown as a “black box,” but manufacturer’s instruction book number shall be referenced and terminal connections shown.
13. Isolation points (state links, PK-2 and FT-1 blocks, etc.) including terminal identification.
14. All circuit elements and components, with device designation, rating and setting where applicable. Coil voltage is shown only if different from nominal control voltage.
15. Size, type, rating and designation of all fuses.
16. Phase sequence designation as ABC or CBA.
17. Potential transformers – nameplate ratio, polarity marks, rating, primary and secondary connections (see Requirements for minimum ratings).
18. Current transformers (including aux. CT's) – polarity marks, rating, tap ratio and connection.

Unit Capability Data

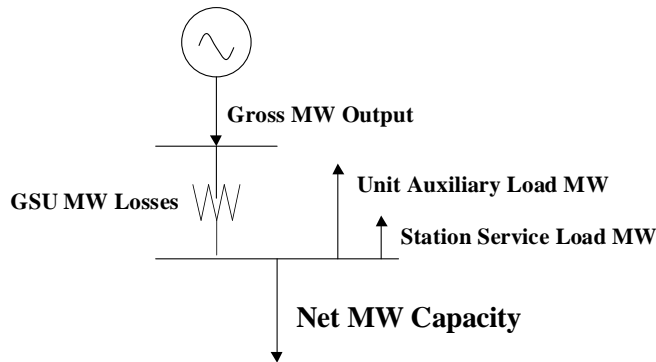

Net MW Capacity = (Gross MW Output - GSU MW Losses – Unit Auxiliary Load MW - Station Service Load MW)

Primary Fuel Type: _____

Maximum Summer (92° F ambient air temp.) Net MW Output: _____

Maximum Summer (92° F ambient air temp.) Gross MW Output: _____

Minimum Summer (92° F ambient air temp.) Gross MW Output: _____

Maximum Winter (30° F ambient air temp.) Gross MW Output: _____

Minimum Winter (30° F ambient air temp.) Gross MW Output: _____

Gross Reactive Power Capability at Maximum Gross MW Output (Leading and Lagging): _____

***** Please submit Reactive Capability Curve when available**

Individual Unit Auxiliary Load at Maximum Summer MW Output (MW/MVAR): _____

Individual Unit Auxiliary Load at Minimum Summer MW Output (MW/MVAR): _____

Individual Unit Auxiliary Load at Maximum Winter MW Output (MW/MVAR): _____

Individual Unit Auxiliary Load at Minimum Winter MW Output (MW/MVAR): _____

Station Service Load (MW/MVAR): _____

Please provide any comments on the expected capability of the unit:

Unit Generator Dynamics Data

MVA Base (upon which all reactances, resistance and inertia are calculated): _____

Nominal Power Factor: _____

Terminal Voltage (kV): _____

Unsaturated Reactances (on MVA Base)

Direct Axis Synchronous Reactance, $X_{d(i)}$: _____

Direct Axis Transient Reactance, $X'_{d(i)}$: _____

Direct Axis Sub-transient Reactance, $X''_{d(i)}$: _____

Quadrature Axis Synchronous Reactance, $X_{q(i)}$: _____

Quadrature Axis Transient Reactance, $X'_{q(i)}$: _____

Quadrature Axis Sub-transient Reactance, $X''_{q(i)}$: _____

Stator Leakage Reactance, X_l : _____

Negative Sequence Reactance, $X_{2(i)}$: _____

Zero Sequence Reactance, X_0 : _____

Saturated Sub-transient Reactance, $X''_{d(v)}$ (on MVA Base): _____

Armature Resistance, R_a (on MVA Base): _____ at _____ ° C

Time Constants (seconds)

Direct Axis Transient Open Circuit, T'_{do} : _____

Direct Axis Sub-transient Open Circuit, T''_{do} : _____

Quadrature Axis Transient Open Circuit, T'_{qo} : _____

Quadrature Axis Sub-transient Open Circuit, T''_{qo} : _____

Inertia, H (kW-sec/kVA, on KVA Base): _____

Speed Damping, D : _____

Saturation Values at Per-Unit Voltage [$S(1.0)$, $S(1.2)$]: _____

*** *Please submit generator certified test report information when available*

IEEE dynamic model parameters:

Governor Model: _____

Exciter Model: _____

Power System Stabilizer Model: _____



CAUTION: Printed copies of this document are uncontrolled and may be obsolete.
Always check for the latest revision prior to use.

Unit Transformer Data

Transformer MVA Base: _____

Transformer Impedance (R+jX, on transformer MVA Base): _____

Transformer Rating (MVA): _____

Transformer Low-side Voltage (kV): _____

Transformer High-side Voltage (kV): _____

Transformer Off-nominal Turns Ratio: _____

Transformer Number of Taps and Step Size: _____

****** Please submit transformer certified test report information when available***

GSU/Collector step up transformer manufacturer's certified test report to include positive- and zero-sequence impedances between **all** windings (including tertiary).

In addition, please indicate whether the transformer is shared with other units.

2.3 Design Requirements and Considerations

Nominal voltages on the AEP transmission system are 765 kV, 500 kV, 345 kV, 230 kV, 161 kV, 138 kV, 115 kV, 69 kV, 46 kV, and 34.5 kV. The Requester shall contact AEP for information on the specific circuit(s) presently serving or available to serve their facility.

For parallel operation, the Requester shall submit one-line drawings of the associated equipment to AEP and/or the RTO/ISO for review of the protective, metering and remote monitoring/control functions. Changes required by AEP shall be made prior to final issue of drawings and AEP shall be provided with final copies of the revised drawings. AEP will review only those portions of the drawings which apply to protection, metering and remote monitoring/control which affect the AEP system. To aid the Requester, AEP may make suggestions on other areas, but will not assume responsibility for the correctness pertaining to Requester's system.

The Requester shall maintain an operating log at each generating facility that, at a minimum, will indicate changes in operating status (available or unavailable), maintenance outages, trip indications or other unusual conditions found upon inspection. For generators which are "block-loaded" to a specific MW level, changes in this setting shall also be logged; AEP may waive this requirement at its discretion. The Requester, as required by NERC and RTO/ISO, will maintain reliability information.

Regarding MW production, the Requester may be required to adjust their generation at certain times to maintain reliability. For example, when system loading is at minimum levels and the Requester has not scheduled the sale/transport of their production outside the AEP Balancing Authority/Control area, or when transmission maintenance is required, the Requester should be prepared to reduce generation to maintain operation within system limitations.

The Requester is solely responsible for properly synchronizing its generation with the AEP transmission system and shall provide to AEP for review, the most current specifications for interconnection equipment, including control drawings and one-line diagrams. Review of Requester's specifications shall not be construed as confirming or endorsing the design or as a warranty of safety, durability or reliability of the facility or equipment. Please refer to Appendix G, section: "Requester with Facilities that are a Generation Source."

The Requester may be required to change the facility or equipment as required by AEP to meet future changes in the transmission system. The Requester shall be given reasonable notice by AEP prior to the date that the required changes in the Requester's facilities must be made.

The Requester shall not take actions to energize a circuit or station facility owned by AEP that has become de-energized, unless under direction of AEP Transmission Operations.

The Requester's generating equipment shall not cause objectionable interference with the electric service provided to other customers nor jeopardize the security of the power system. In order to minimize the interference of the Requester's parallel generation with the AEP transmission system, the Requester's generation shall meet the following criteria:

2.4 Voltage Requirements

The Requester's generating equipment shall not cause excessive voltage excursions. The Requester shall operate generating equipment in such a manner that the voltage levels on the system are not adversely impacted. The Requester shall provide an automatic method of disconnecting its generating equipment from the AEP facilities to protect against excessive voltage excursions. Specification of the generator voltage or power factor schedules will be provided by AEP. The Requester will install, operate, and service an automatic voltage regulator to maintain the assigned voltage schedule to the extent possible. Steady-state deviation from the voltage schedule of $\pm 0.5\%$ is permissible.

 AMERICAN ELECTRIC POWER BOUNDLESS ENERGY™	TRANSMISSION PLANNING GUIDELINE Requirements for Connection of New Facilities or Changes to Existing Facilities Connected to the AEP Transmission System	Rev. 2	TP-0001
			Page 30 of 99

The generation facility must be capable of continuous non-interrupted operation during normal system conditions and during abnormal conditions. Steady state normal voltages could range from 95% to 105% of nominal. Voltages may temporarily be outside this range during emergency or transient system conditions. All reasonable measures should be taken to avoid tripping of the generation facility due to high or low voltage.

The auxiliary equipment of the Requester's facility shall not cause excessive voltage flicker on the electric facilities of AEP during plant startup conditions. Voltage Flicker is to be measured at the Requester's service point and shall not exceed the short and long term limits specified in IEEE Standard 1453-2004. Reference Appendix A (AEP Power Quality Requirements) for voltage flicker standards.

All three-phase generation shall produce balanced 60 Hertz voltages. Voltage unbalance attributable to a Generator Connection's combined generation and load shall not exceed 1.0% measured at the point-of-common coupling. Voltage unbalance is defined as the maximum phase deviation from average as specified in ANSI C84.1, "American National Standard for Electric Power Systems and Equipment - Voltage Ratings, 60 Hertz."

2.5 Power Factor Requirements

The Requester's generator(s) must have the capability of ranging from 0.85 lagging to 0.95 leading power factor. The Requester must generate the VAR demand of plant equipment. In order to maintain security of the power system, AEP may request that the Requester accept or supply reactive power. For synchronous generators, the generator voltage-VAR schedule, voltage regulator, and transformer ratio settings will be jointly determined by AEP and the Requester to ensure proper coordination of voltages and regulator action. For situations where generator voltage or power factor scheduling is inappropriate, adherence to a unity power factor at the point of interconnection may be substituted. In cases where starting or load changes on induction generators have an adverse impact on system voltage, AEP is to be consulted on techniques required to bring voltage changes to acceptable levels.

2.6 Power Quality Requirements

The Requester shall not cause excessive voltage flicker or harmonic waveform distortion on the transmission system. The Requester shall adhere to the power quality requirements outlined in Appendix A.

2.7 Frequency Requirements

The AEP transmission system frequency operates at a nominal 60.0 Hz with a variation of ± 0.05 Hz. The operating frequency of the Requester's equipment shall not deviate from this AEP system frequency. Under emergency conditions, the transmission system could operate outside of this range for a limited period of time. Please refer to "Frequency Protection" in Appendix G.

2.8 Abnormal Frequency Operation

The Requester is responsible for providing frequency-sensing equipment required to protect its facility during abnormal frequency operation. Non-interrupted operation as specified by the generator manufacturer or the range specified in the figure above is required during abnormal frequency episodes.

The Requester's generator will not separate from the AEP system during under frequency conditions until all under frequency load shedding equipment on the AEP system has operated. Reference the "Automatic Under frequency Load Shedding" section 8.0 of Appendix G.

2.9 GSU Configurations

AEP has established Generator Step-Up (GSU) transformer requirements for Requester-owned parallel generation, with specific protection, metering and operating requirements based upon typical AEP installations. The final decision as to the requirements for each installation will be made depending on the Requester's electrical location of the generator, the existing electrical facilities, the rating of existing electrical equipment and generators connected to the system, available short circuit contributions, etc.

Grounded Wye - Delta connected GSU transformers are specified for parallel generation connections. The Wye connection will be connected to the transmission system on lines rated 23

 AMERICAN ELECTRIC POWER BOUNDLESS ENERGY™	TRANSMISSION PLANNING GUIDELINE Requirements for Connection of New Facilities or Changes to Existing Facilities Connected to the AEP Transmission System	Rev. 2	TP-0001
			Page 31 of 99

kV and above with the Delta connection on Requester's side. The ground source will provide a means for the Requester to separate its equipment from the bulk system for ground faults that have not been cleared in a reasonable amount of time. The low-side Delta connection will limit the ground fault currents the Requester will experience for faults on their system.

2.10 Induction Generators

Reactive power demands of induction generators may pose transmission system problems, depending on the generator size. Some installations may require capacitors to be installed to limit the adverse effects of reactive power flow on the AEP system. The installation of capacitors for reactive power supply at or near an induction generator greatly increases the risk that the induction machine may become self-excited if it is inadvertently isolated from the bulk transmission system. A self-excited induction generator can produce abnormally high voltages which can cause damage to the equipment of other customers. Over-voltage relays can limit the duration of such over-voltages but cannot control their magnitude because of the rapid voltage rise which occurs with self-excitation. Because of these problems, the reactive power supply for induction generators must be studied on an individual basis. Where self-excitation problems appear likely, special service arrangements will be required in order to avoid the induction generator from becoming isolated with small amounts of system load. AEP should be consulted during the planning and design process of installations considering induction generators.

2.11 Inverter Systems

The reactive power requirements of inverter systems are similar to induction generators. Consequently, the general requirements discussed in the previous section shall apply. Inverter systems are also capable of isolated operation. Self-commutated inverters are capable of isolated operation by design while line-commutated inverters could operate isolated if connected to rotating machines that provide the necessary commutation. Because of the possibility of self-excited operation, inverter systems are treated as induction machines in these requirements.

At present no standards exist for the harmonic output of power inverters. If a Requester using such a device for parallel generation is found to be interfering with other customers or utilities, or if standards are adopted in the future, Requester may be required to install filtering or other equipment to bring the harmonic output to an acceptable level. AEP should be consulted during the planning and design process of installations considering inverter systems.

2.12 Wind Generation Requirements

Reactive power requirements for induction generators, typically used in wind generation systems, may pose transmission system problems. The installation of capacitors or dynamic voltage control devices to mitigate reactive power problems and allow higher power factor operation must be studied and evaluated on an individual basis.

Wind energy plants can cause significant voltage variations as the MW output changes in response to varying wind input conditions. Protective systems must be installed in order to prevent this voltage variation from causing problems on the AEP transmission system. Voltage variations at the point of interconnection must comply with the voltage flicker standards specified in Appendix A.

In general, the wind energy plant must not trip off-line for faults remote from the point of interconnection, nor can the behavior of the wind energy plant cause other generating units to trip off-line.

Malfunction(s) at one turbine on the generator, the collector system serving a set of turbines, or at a point of interconnection, shall not result in the cascaded tripping of other generating units, unless required to prevent damage to electrical facilities, or to isolate faulty devices, equipment or circuits.

 AMERICAN ELECTRIC POWER BOUNDLESS ENERGY™	TRANSMISSION PLANNING GUIDELINE Requirements for Connection of New Facilities or Changes to Existing Facilities Connected to the AEP Transmission System	Rev. 2	TP-0001
			Page 32 of 99

2.12.1 Low Voltage Ride-Through (LVRT) Capability

Wind generating plants shall have LVRT capability and adhere to applicable RTO/ISO standards or criteria. In ERCOT, wind generating plants are required to remain interconnected during three-phase faults on the transmission system for voltage levels as low as zero volts with durations of no more than nine (9) cycles. As a part of the System Impact Study, AEP will simulate the response of the wind turbine dynamic models in order to demonstrate LVRT performance. AEP will also determine the clearing time requirement at the wind generating plant point of connection using AEP relaying standards, and document the requirement, as necessary, in the initial or amended Interconnection Agreement.

2.12.2 Power Factor Requirements

Wind generating plants shall be capable of operating at power factors ranging from 0.95 leading to 0.95 lagging as measured at the point of interconnection.

2.12.3 System Grounding

The grounding of the Requester's system at the transmission voltage level will be considered on a case-by-case basis.

2.12.4 Transient Stability Performance

Transient stability performance of the generators operating within the facility is the responsibility of the Requester. Transient stability performance should be in accordance with the transient stability criteria applied to the AEP network. In addition to transient stability studies included in the scope of the system impact study, additional studies may be performed to verify proper transient stability performance with final (as commissioned) equipment and facility data.

2.12.5 Excitation Control

The Requester's generator(s) excitation system response ratio shall not be less than 0.5 (five-tenths). The Requester's generator(s) excitation system(s) shall conform, as near as achievable, to the field voltage vs. time criteria specified in American National Standards Institute Standard C50.13-1989 in order to permit adequate field forcing during transient conditions. Depending upon applicable RTO/ISO Operating Guides or Criteria, or the results of AEP small signal stability studies (subject to RTO/ISO review), it may be necessary for Requester to install power system stabilizers (PSS) on Requester's exciter system. If a PSS is required, AEP will require Requester to install such PSS in a manner that is not discriminatory to Requester. Each generator's exciter and exciter controls shall have a ride-through capability for significant system voltage disturbances (i.e., utilize UPS or DC design). The Requester shall ensure that the Automatic Voltage Regulator (AVR) of each generating unit is in service and operational. If the AVR is removed from service for maintenance or repair, AEP Transmission Operations shall be notified.

2.12.6 Speed Governing

The speed governors of the Requester's generator(s) shall be able to respond to interconnection frequency deviations and help return interconnection frequency to normal following an upset on the bulk transmission system to assist in maintaining interconnection stability.

2.12.7 Automatic Generation Control

Depending upon various balancing factors applicable to tie line and frequency regulation, provisions for dispatch control of the generation facility may be required.

2.12.8 Black Start Capability

Depending upon the geographic location of Requester's generation and other considerations applicable to system restoration in the event of a blackout, AEP may desire to utilize the black

 AMERICAN ELECTRIC POWER BOUNDLESS ENERGY™	TRANSMISSION PLANNING GUIDELINE Requirements for Connection of New Facilities or Changes to Existing Facilities Connected to the AEP Transmission System	Rev. 2	TP-0001
			Page 33 of 99

CAUTION: Printed copies of this document are uncontrolled and may be obsolete.
Always check for the latest revision prior to use.

start capability of Requester's generation. If deemed appropriate for a particular installation, it will be addressed in the applicable Interconnection Agreement.

2.12.9 Sub-Synchronous Torsional Interactions or Resonance

Depending upon the specific location of the generation facility in the transmission network, close electrical proximity to series compensated transmission lines or FACTS devices may result in undesirable or damaging sub-synchronous currents. Also, the provision of high speed reclosing following transmission line faults may result in excessive torsional duties. The Requester must provide AEP with immunity from damaging torsional oscillations resulting from all transmission system operations, and insure the turbine-generator is not excited into resonance by normal system operations.

System Protection Requirements

Reference Appendix G (AEP Protection and Disturbance Monitoring Requirements for Connecting to the AEP Transmission Grid).

2.12.10 Metering/SCADA

Reference Appendix F (AEP Metering Requirements for Transmission Interconnection Facilities) and Appendix E (AEP SCADA/RTU Requirements)

2.12.11 Voice Communications

Voice communications satisfactory to AEP shall be installed and maintained by Requester per requirements of the RTO/ISO, operating company, transmission company, or applicable agreement. Examples of voice communications include a dedicated Voice Dispatch Circuit and connections to the public telephone network. For more detail on these requirements, reference Appendix F.

2.13 Transmission Line Design, Loading, Clearance, Insulation and Structural Design Requirements

Upon determination of the point of connection, the design and construction of new transmission line facilities on the AEP system that are necessary to connect the Requester's facilities shall be completed in accordance with the following criteria:

2.13.1 New Transmission Lines Serving only the Requester and not Owned by AEP

New transmission lines that are "taps" of existing transmission circuits and that are built solely to serve the Requester, or do not otherwise involve carrying services to other customers or delivery points and will not be owned by AEP, require the Requester to install breakers, protection, and control for all Requester-owned facilities, and may be built to any criteria determined by the facility owner and operator so long as it meets the minimum requirements of:

- 1) ANSI-C2, National Electrical Safety Code (NESC), latest edition
- 2) NFPA 70, National Electrical Code (NEC), latest edition
- 3) Governmental agencies as needed to obtain permits to construct the line (U.S Army Corps of Engineers, FAA, etc.)
- 4) Any additional applicable state and local code or criteria.

The facilities must be designed, built, operated, and maintained to perform equivalent or superior to AEP-owned facilities in that region.

	TRANSMISSION PLANNING GUIDELINE Requirements for Connection of New Facilities or Changes to Existing Facilities Connected to the AEP Transmission System	Rev. 2	TP-0001
			Page 34 of 99

2.13.2 New Transmission Lines Serving the Requester and Integrated in the AEP Network

New transmission lines that involve carrying AEP services to more than one customer, or that AEP will own or maintain shall, in addition to the criteria indicated above, be designed in accordance with AEP System Standard TLES-10 (Clearances, Mechanical Loadings and Load Factors Applicable to Structures, Foundations Hardware, Insulators, Conductors, Ground Wire and Line Design) and shall be constructed with AEP standard materials.

2.14 Dynamic MVAR Capability Requirements

The dynamic MVAR capability at the current MW generation amount shall be provided in real time. If this dynamic MVAR capability is not available in real time, a dynamic capability curve plotted as a function of MW output shall be provided. The shunt static reactive available, but not in service, shall be provided in sufficient detail to determine the amount of dynamic and static reactive reserve available.

2.15 Disturbance Monitoring Requirements

For disturbance monitoring of the interconnection facilities, AEP requires a combination of station data repository points and event recordings. AEP's station data repository collects station data repository points. The Requester shall supply event recordings to AEP by from the Requester's equipment. AEP will own and install station data repository and associated recording equipment inside AEP's facilities. AEP recording equipment, consisting of one or more intelligent electronic devices, monitors the interconnection facilities the station data repository polls this equipment. AEP will develop a project-specific station data repository points list that is based upon the project's electrical configuration. For such purpose, the Requester shall be responsible for providing AEP with one-line diagrams of the Requester's facilities. For thermal powered generation, the Requester is required, upon AEP's request, to provide event recordings per generator in a format satisfactory to AEP. For all other generation, the Requester is required, upon AEP's request, to provide event recordings per collection feeder in a format satisfactory to AEP. All disturbance monitoring equipment shall be equipped for time synchronization. AEP's monitoring requirements do not reduce the Requester's obligation to meet all of NERC's disturbance monitoring requirements.

2.16 Coordination of Protective Systems

NERC standards require that protective systems be coordinated among operating entities. These standards require transmission and generator operators to notify appropriate entities of relay or equipment failures that could affect system reliability. In addition, transmission and generator operators must coordinate with appropriate entities when new protective systems are installed, or when existing protective systems are modified. Appendix G describes how AEP and the Requester will coordinate protective system information.

2.16.1 Placement of Generation Monitoring Equipment

To facilitate AEP's monitoring of generation interconnections at transmission and distribution voltage, AEP-owned generation monitoring equipment (typically the RTU, SDR, DME and metering) is installed at AEP's substation. (Project-specific conditions may not warrant the metering to be co-located at the same facility with the RTU, SDR and DME. Placement of the SDR/DME is subject to Disturbance Monitoring Requirements identified in Section 2.15.)

2.16.2 Generation Monitoring Equipment placed at the AEP substation

For monitoring equipment that is placed in the AEP substation (identified in Section 1 above), AEP provides power, equipment mounting space, and communications to the AEP dispatch office. Fiber is required between the Generator's plant and the AEP substation to accommodate the RTU in the AEP substation. Generation interconnection SCADA data is collected at the Generator's plant. The AEP RTU in AEP's substation polls this data via fiber.

Such monitoring equipment is placed in the AEP substation for transmission voltage interconnections typically including a) plant capacity equal to or greater than 1000 MW, b) a- plant

 AMERICAN ELECTRIC POWER BOUNDLESS ENERGY™	TRANSMISSION PLANNING GUIDELINE Requirements for Connection of New Facilities or Changes to Existing Facilities Connected to the AEP Transmission System	Rev. 2	TP-0001
			Page 35 of 99

CAUTION: Printed copies of this document are uncontrolled and may be obsolete.
Always check for the latest revision prior to use.

designated or subject to designation as critical by NERC, c) a plant subject to Nuclear Regulatory Commission oversight, d) interconnections at nominal 345 kV and above with a dedicated transmission line from each generation unit to AEP's substation and e) combined cycle plants regardless of transmission interconnection voltage with a dedicated transmission line from each generation unit to AEP's substation. For such monitoring equipment placed in the AEP substation for transmission voltage interconnections, two RTUs are required in the AEP substation: one generation-specific RTU for dedicated plant monitoring, and one transmission-specific RTU for AEP to operate its substation.

This monitoring equipment is placed in the AEP substation for distribution voltage interconnections unless conditions warrant otherwise. Such monitoring equipment that is placed in the AEP substation for distribution voltage interconnections, one RTU is required in the AEP substation for the generation monitoring function and AEP's substation operations. A dedicated port on the AEP RTU at the AEP substation polls the generation-specific data from the plant. Generation-specific and transmission-specific substation operation data is collected in a common AEP RTU.

For generation monitoring equipment placed in AEP's substation, the Generator shall collect all AEP-required generation-specific SCADA inputs in one or more Generator-owned and AEP-approved interface devices in the plant. The AEP RTU in AEP's substation will directly poll each AEP-approved interface device. Polling will be done via a dedicated fiber pair in the fiber optic cable between the plant and AEP's substation. The Generator shall provide and own an AEP-approved electrical-to-optical converter on the plant-end of each fiber pair sourcing generation-specific SCADA inputs to AEP's RTU.

In retrofit situations, a specific generation monitoring device will be relocated, such as replacing an obsolete AEP fault recorder in the Generator's plant with an SDR/DME in the AEP substation, subject to Disturbance Monitoring Requirements identified in Section 2.15.

2.17 Ownership, Cost, Maintenance and Compliance Responsibility

The Requester shall install, operate and maintain in good order and repair, and without cost to AEP, all facilities that AEP requires for the safe operation of the Requester's facilities connected to AEP's electrical system. The Requester shall install, operate, and maintain its electrical facility, at all times, in conformity with good utility practice, National Electrical Safety Code, RTO/ISO requirements, NERC Reliability Standards, National Electric Code, and applicable laws and regulations. Any electrical facility operated as a part of the transmission grid shall have the ownership, cost, maintenance and NERC and RTO/ISO compliance responsibilities outlined in the IA or ILDSA.

2.18 Generator Connection Final Approval

The Requester's construction, testing, and maintenance of the protective equipment it provides for AEP transmission system protection shall be subject to AEP's review and approval. Prior to establishing service for operation, the Requester shall obtain approval from AEP for the generation, electrical equipment specifications, and operating procedures.

An executed agreement with AEP and other appropriate entities for the generation addition is required for final approval. Failure to meet the requirements stated herein to the satisfaction of AEP may result in a refusal to permit operation of the generation.

AEP's review and approval of the proposed generation facility specifications and plans shall not be construed as confirming or endorsing the design or warranting the safety, durability, reliability, adequacy, or otherwise of the generation facility.

 AMERICAN ELECTRIC POWER BOUNDLESS ENERGY™	TRANSMISSION PLANNING GUIDELINE Requirements for Connection of New Facilities or Changes to Existing Facilities Connected to the AEP Transmission System	Rev. 2	TP-0001
			Page 36 of 99

3.0 TRANSMISSION INTERCONNECTION (TI) FACILITIES – CONNECTION REQUIREMENTS, TYPICAL NETWORK INTERCONNECTIONS

3.1 Design Information

The nominal voltages of the AEP transmission system are 765 kV, 500 kV, 345 kV, 230 kV, 161 kV, 138 kV, 115 kV, 69 kV, 46 kV, and 34.5 kV. Contact the appropriate AEP Transmission Planning department for information on the specific circuit(s) serving or available to serve the TI Requester’s facility.

The table below presents the AEP transmission system voltage criteria:

AEP Transmission System Voltage Ranges

RTO/ISO	All Facilities In-Service		One Facility Out of Service	
	HV (Below 200 kV)	EHV (200 kV and Above)	HV (Below 200 kV)	EHV (200 kV and Above)
ERCOT	95% - 105%	95% - 105%	90% - 105%	90% - 105%
PJM	95% - 105%	95% - 105%	92% - 105%	90% - 105%
SPP	95% - 105%	95% - 105%	90% - 105%	90% - 105%

Under certain conditions, the AEP transmission system may operate for a period of time outside of the defined ranges. The Requester is responsible for providing voltage sensing equipment required to protect its equipment during abnormal voltage operation.

Most of AEP’s EHV transmission circuits are protected by two different high-speed relaying systems, such as Directional Comparison Blocking (DCB), Permissive Overreaching Transfer Trip (POTT) and Current Differential schemes. Most of AEP’s 100 kV – 200 kV transmission circuits are protected by a single high-speed carrier current relaying system, with Step Distance phase and directional ground overcurrent relaying backup schemes. Most of AEP’s circuits below 100 kV are protected by a primary and backup phase and ground over-current relay scheme. AEP will determine the appropriate protection for each TI Request. AEP may choose to deviate from these schemes due to the requirements of a specific project. A more detailed description of AEP protection practices can be found in Appendix G.

To ensure proper coordination with AEP equipment, the Requester shall provide AEP’s Protection and Control Engineering department the specific relay setting information on the Requester facilities.

As most short circuit faults on overhead lines are of a temporary nature, it is AEP’s normal practice to reclose the circuit breakers on such lines (high-speed) after they have automatically tripped due to the operation of a pilot scheme. This high-speed reclosing typically involves an intentional time delay of 15 – 30 cycles and some additional time required for the operating speed of the relays and circuit breaker(s). Reclosing for 69 kV lines and those lines that have a high-side transformer recovery scheme have a second reclosing attempt. This second reclose also has an intentional time delay. This practice improves continuity of service to all AEP customers. These practices can be modified based on the circumstances and requirements at specific locations.

The Requester may be responsible for the installation of equipment to island during under frequency or under voltage conditions. This may include transfer trip equipment, at either the AEP facility (local end), the Requester facility (remote end), or both locations.

The Requester shall change its facility or equipment as may be required by NERC, RTO/ISO, or AEP to meet future changes in the transmission system. The Requester shall be given reasonable notice by AEP prior to the date that required changes in the Requester’s facilities must be made. AEP has specific guidelines for site selection and must approve the interconnection substation location and design.

AEP reserves the right to inspect, calibrate, test and maintain the Requester’s protective equipment located on AEP property that is associated with the protection of AEP’s system.

3.2 General Operating and Design Requirements

The Requester is solely responsible for properly connecting its equipment to AEP and shall provide to AEP for review its most current specifications for interconnection equipment, including drawings and one-line diagrams. AEP's review of the Requester's specifications shall not be construed as confirming or endorsing the design or as a warranty of safety, durability, or reliability of the facility or equipment.

The Requester shall not energize a de-energized circuit owned by AEP unless under the direction of AEP Transmission Operations or except by automatic relay operation approved by AEP.

The Requester shall operate its system in such a manner that the voltage levels on the system are maintained at reliable levels as per applicable RTO/ISO Operating Guides or Criteria.

3.3 Power Quality Requirements

The Requester shall not cause excessive voltage flicker or harmonic waveform distortion on the transmission system. The Requester shall adhere to the power quality requirements outlined in Appendix A.

3.4 System Protection Requirements

Prior to the design phase, the Requester and AEP shall arrive at a mutual agreement as to the type and model numbers of equipment related to the proposed pilot relaying scheme; this is to ensure the proper operation and equipment compatibility.

The Requester shall install protective devices (relays, circuit breakers, etc.), metering equipment, and synchronizing equipment as required by AEP. The protective devices may differ in equipment between installations.

The Requester shall submit one-line drawings of their interconnection equipment to AEP for review of the protective, metering and remote monitoring/control functions. Changes required by AEP shall be made prior to final issue and AEP shall be provided with final copies of the revised drawings. AEP will only review the portions of the drawings which apply to protection, metering and remote monitoring/control that effect the AEP system. To aid the Requester, AEP may make suggestions on other areas, but will not assume responsibility for the correctness pertaining to Requester's system.

The Requester is responsible for the stability of its system and providing adequate facilities so that critical fault clearing times are met.

AEP shall require dedicated communication facilities be installed, at the Requester's expense, as part of relay protection, remote monitoring/control and remote metering. Direct voice contact between AEP and Requester is required for switching. For more detail on these requirements reference Section 5.1.7 and Communication Requirements in Section 8.5.

The Requester may not connect to AEP's system until consent has been given by AEP. AEP reserves the right to inspect the Requester's facility and witness testing of equipment or devices associated with the interconnection. Additional operating procedures may be included in the Interconnection Agreement. Additional details pertaining to System Protection can be found in Appendix G.

3.5 Ownership, Cost, Maintenance and Compliance Responsibility

The Requester shall install, operate and maintain in good order and repair, and without cost to AEP, all facilities required by AEP for the safe operation of the Requester's facilities connected to AEP's electrical system. The Requester's electrical facility shall be installed, operated, and maintained by the Requester at all times in conformity with good utility practice, National Electrical Safety Code, RTO/ISO requirements, NERC Reliability Standards, National Electric Code, and applicable laws and regulations. Any electrical facility operated as a part of the transmission grid shall have the ownership, cost, maintenance and NERC and RTO/ISO compliance responsibilities outlined in the IA or ILDSA. The Requester shall provide AEP with preventative maintenance (PM) frequencies and/or maintenance program guidelines to ensure coordinated testing between the various protection equipment.

 AMERICAN ELECTRIC POWER BOUNDLESS ENERGY™	TRANSMISSION PLANNING GUIDELINE Requirements for Connection of New Facilities or Changes to Existing Facilities Connected to the AEP Transmission System	Rev. 2	TP-0001
			Page 38 of 99

3.6 Metering/SCADA

Reference Appendix E (AEP Metering Requirements for Transmission Interconnection Facilities).

3.7 Voice Communications

Voice communications satisfactory to AEP shall be installed and maintained by Requester per requirements of the RTO/ISO, operating company, transmission company, or applicable agreement. Examples of voice communications include a dedicated Voice Dispatch Circuit and connections to the public telephone network. For more detail on these requirements, reference Communication Requirements in Appendix F (AEP SCADA RTU Requirements for Transmission Interconnection Facilities).

3.8 Transmission Line Design, Loading, Clearance, Insulation and Structural Design Requirements

Upon determination of the point of connection, the design and construction of new transmission line facilities on the AEP system that are necessary to connect the Requester's facilities shall be completed in accordance with the following criteria:

3.8.1 New Transmission Lines Serving only the Requester and not Owned by AEP

New transmission lines that are "taps" of existing transmission circuits built solely to serve the Requester, or do not otherwise involve carrying services to other customers or delivery points, and will not be owned by AEP, require the Requester to install breakers, protection, and control for all Requester-owned facilities, and may be built to any criteria determined by the facility owner and operator so long as it meets the minimum requirements of:

- A) ANSI-C2, National Electrical Safety Code (NESC), latest edition
- B) NFPA 70, National Electrical Code (NEC), latest edition
- C) Governmental agencies as needed to obtain permits to construct the line (U.S Army Corps of Engineers, FAA, etc.)
- D) Any additional applicable state and local code or criteria.

The facilities must be designed, built, operated, and maintained to perform equivalent or superior to AEP-owned facilities in that region.

3.8.2 New Transmission Lines Serving the Requester and Integrated into the AEP Network

New transmission lines that involve carrying AEP services to more than one customer, or that will be owned or maintained by AEP shall, in addition to the criteria indicated above, be designed in accordance with AEP System Standard TLES-10 (Clearances, Mechanical Loadings and Load Factors Applicable to Structures, Foundations Hardware, Insulators, Conductors, Ground Wire and Line Design) and be constructed with AEP standard materials.

3.9 Asynchronous Network Interconnections

This section on Asynchronous Network Interconnections is focused primarily on conventional line commutated HVDC systems as these have the most complicated interconnection requirements. Voltage-sourced converters (VSCs) and variable frequency transformers (VFTs) must be treated on a case-by-case basis.

3.9.1 Design Information

Asynchronous connections to the AEP system presently exist at the 138 kV and 345 kV voltage levels. These connections are found where there is an interconnection between the ERCOT system and either SPP or CFE (Comisión Federal de Electricidad) as ERCOT does not allow synchronous connections to entities outside of ERCOT.

Most of AEP's EHV transmission circuits are protected by two different high-speed pilot relaying systems, such as Directional Comparison Blocking (DCB), Permissive Overreaching Transfer Trip (POTT) and Current Differential schemes. Most of AEP's 100 kV – 200 kV transmission circuits are protected by a single high-speed pilot relaying system, with Step

 AMERICAN ELECTRIC POWER BOUNDLESS ENERGY™	TRANSMISSION PLANNING GUIDELINE Requirements for Connection of New Facilities or Changes to Existing Facilities Connected to the AEP Transmission System	Rev. 2	TP-0001
			Page 39 of 99

CAUTION: Printed copies of this document are uncontrolled and may be obsolete.

Always check for the latest revision prior to use.

Distance phase and directional ground overcurrent relaying backup schemes. Most of AEP's circuits below 100 kV are protected by a primary and backup phase Step Distance scheme with a directional ground over-current relay. AEP will determine the appropriate protection for each TI Request. AEP may choose to deviate from these schemes due to the requirements of a specific project. A more detailed description of AEP protection practices can be found in Appendix G.

In the case of a circuit connected to an Asynchronous converter, it is necessary to employ two high speed pilot relaying systems regardless of the voltage level. These systems could consist of Current Differential, POTT, and/or weak feed DCB schemes. Current Differential schemes are preferred. The ability to account for weak sources is imperative when protecting a line with a line-commutated inverter as a source.

To ensure proper coordination with AEP equipment, the Requester shall provide AEP's Protection and Control Engineering department the specific relay setting information on the Requester facilities.

As most short circuit faults on overhead lines are of a temporary nature, it is AEP's normal practice to reclose the circuit breakers on such lines (high-speed) after they have automatically tripped due to the operation of a pilot scheme. This high-speed reclosing typically involves an intentional time delay of 15 cycles and some additional time required for the operating speed of the relays and circuit breaker(s). Reclosing requirements in the vicinity of an HVDC converter station will have to be studied based on the specific details of the proposed station and its location. The possibility of transient overvoltages must be taken into account. This becomes quite critical in the case where the HVDC facility is located in a weak system.

The Requester shall change its facility or equipment as may be required by NERC, RTO/ISO or AEP to meet future changes in the transmission system. The Requester shall be given reasonable notice by AEP prior to the date that required changes in the Requester's facilities must be made.

AEP reserves the right to inspect, calibrate, test and maintain Requester protective equipment located on AEP property that is associated with the protection of AEP's system.

3.10 General Operating and Design Requirements

HVDC converter stations have many characteristics that differ from conventional transmission lines and generation. These characteristics make the design process very dependent on the power system topology and the transient and dynamic environment in the vicinity of the proposed facility. Some of these characteristics are as follows:

- A) A relatively complex closed loop control system. Power transfer can be extinguished by control action rather than the opening of a circuit breaker. The effects of minor AC system imbalances may, in some cases, be amplified in the converter controls.
- B) Conventional HVDC converter stations generate many harmonics. As a result, filters are required on the AC bus. The typical 12 pulse converter will generate 11th and 13th harmonics, and to a lesser extent, 23rd and 25th harmonics and higher. The filter design, however, must account for the effects of the balance of the AC system. A harmonic study for the area in question is therefore a necessity.
- C) Conventional HVDC converter stations require VAR support. As a result, depending on location, reactive compensation may be required. Reactive studies may be required in order to determine the specific requirements associated with a HVDC installation.
- D) Filters and reactive devices, as well as AC system disturbances, can create switching transients that can have a major effect on the operation of the converter station.

The incorporation of an HVDC converter station into a power system requires more preliminary study and planning than the average transmission line or generator. The effects of a poorly planned system can create many problems in the future that may be costly to resolve.

 AMERICAN ELECTRIC POWER <small>BOUNDLESS ENERGY™</small>	<u>TRANSMISSION PLANNING GUIDELINE</u> Requirements for Connection of New Facilities or Changes to Existing Facilities Connected to the AEP Transmission System	Rev. 2	TP-0001
			Page 40 of 99

3.11 Power Quality Requirements

HVDC converter stations are sources of harmonics. The switching of filters and reactive compensation banks can create transients. Consequently, power quality issues in the vicinity of converter stations are a major concern. A good summary of power quality and environmental issues can be found in Chapter 13 of the “High Voltage Direct Current Handbook” published by the Electric Power Research Institute (EPRI). AEP Power Quality Requirements are summarized in Appendix A.

3.12 System Protection Requirements

Prior to the design phase, the Requester and AEP shall arrive at a mutual agreement as to the type and model numbers of equipment related to the proposed pilot relaying scheme; this is to ensure proper operation and equipment compatibility. As discussed in section 5.2.1, dual high speed schemes are to be used when an HVDC converter station is a source, regardless of the circuit voltage level. Schemes which are able to detect weak in feeds are required. Power line carrier systems can be affected by noise generated by HVDC converter stations.

The Requester shall install protective devices (relays, circuit breakers, etc.), metering equipment, and synchronizing equipment as required by AEP. The protective devices may differ in equipment between installations.

The Requester shall submit one-line drawings of their interconnection equipment to AEP for review of the protective, metering and remote monitoring/control functions. Changes required by AEP shall be made prior to final issue and AEP shall be provided with final copies of the revised drawings. AEP will review only the portions of the drawings that apply to protection, metering and remote monitoring/control which affect the AEP system. To aid the Requester, AEP may make suggestions on other areas, but will not assume responsibility for the correctness pertaining to Requester’s system.

Additional details pertaining to System Protection can be found in Appendix G.

3.13 Information Required from Converter Station Operator

An excellent description of information required from the converter station operator and the connected utility can be found in Appendices A and B of the “High Voltage Direct Current Handbook” published by the Electric Power Research Institute (EPRI).

3.14 Ownership, Cost, and Maintenance Responsibility

The Requester shall install, operate and maintain in good order and repair, and without cost to AEP, all facilities required by AEP for the safe operation of the Requester’s facilities connected to AEP’s electrical system. The Requester’s electrical facility shall be installed, operated, and maintained by the Requester at all times in conformity with good utility practice, National Electrical Safety Code, RTO/ISO requirements, NERC Reliability Standards, National Electric Code, and applicable laws and regulations. Any electrical facility operated as a part of the transmission grid shall have the ownership, cost, maintenance and NERC and RTO/ISO compliance responsibilities outlined in the Metering/SCADA section of the IA or ILDSA. Reference Appendix E and Appendix F.

 AMERICAN ELECTRIC POWER <small>BOUNDLESS ENERGY™</small>	TRANSMISSION PLANNING GUIDELINE Requirements for Connection of New Facilities or Changes to Existing Facilities Connected to the AEP Transmission System	Rev. 2	TP-0001
			Page 41 of 99

4.0 END-USER CONNECTION (EUC) FACILITIES - CONNECTION REQUIREMENTS

4.1 Design Information

Nominal transmission system voltages presently on the AEP transmission system are 765 kV, 500 kV, 345 kV, 230 kV, 161 kV, 138 kV, 115 kV, 69 kV, 46 kV, and 34.5 kV. Contact the AEP Transmission Planning department for information on the specific circuit(s) available to serve the EUC Requester Facility. The table below presents the AEP transmission system voltage criteria:

AEP Transmission System Voltage Ranges

RTO/ISO	All Facilities In-Service		One Facility Out of Service	
	HV (Below 200 kV)	EHV (200 kV and Above)	HV (Below 200 kV)	EHV (200 kV and Above)
ERCOT	95% - 105%	95% - 105%	90% - 105%	90% - 105%
PJM	95% - 105%	95% - 105%	92% - 105%	90% - 105%
SPP	95% - 105%	95% - 105%	90% - 105%	90% - 105%

If the Requester's supply voltage requirements are more restrictive than specified above, AEP recommends that the Requester consider the addition of appropriate voltage regulation equipment in their facility. Voltage regulation at the point of power consumption is the Requester's responsibility. Under certain conditions, the AEP transmission system may operate for a period of time outside of the defined ranges. The Requester is responsible for providing voltage sensing equipment required to protect its equipment during abnormal voltage operation. The Requester will own the breaker(s), protection and control for all equipment owned by the Requester. AEP has specific guidelines for site selection and must approve the interconnection substation location and design. The Requester is responsible for protection of its facilities from all abnormal conditions occurring on the transmission system. The following should be considered in the design of Requester's Facilities:

- A) The Requester's two winding transformer connected to the AEP transmission system will be connected high-side Delta and low-side grounded Wye. Distribution systems with very high fault currents may require a grounding resistor or inductor in the transformer neutral with AEP approval.
- B) Transformers associated with the bulk transmission system (100 kV and above) should be provided with high-speed protection to minimize damage to the transformer and associated substation equipment, and to limit negative impacts upon the system. A protective zone should be provided for each transformer. The various zones should overlap so that no area is unprotected. Ground switches are not considered acceptable protection.
- C) Power transformer fuses are the most economical means of protecting a transformer. However, AEP recommends that fuses not be used on transformers with ratings larger than 10 MVA (maximum nameplate) due to the inability to adequately protect the transformer for all fault conditions. Use of power fuses is acceptable only at delivery points of 69kV and below. In some cases, fuses may be unacceptable on smaller transformers due to protection requirements. Fuses shall not be used to protect transformers on lines with high-speed protection systems. AEP shall have the final authority to specify transformer protection schemes.
- D) To ensure proper coordination with AEP equipment, the Requester shall provide AEP's Protection and Control Engineering department the specific fuse and relay setting information on the Requester facilities.

CAUTION: Printed copies of this document are uncontrolled and may be obsolete.

Always check for the latest revision prior to use.

- E) If a Requester's facility is located on a transmission line tap for which the transmission line relays cannot adequately protect, the Requester shall provide breakers, wave traps, CCVTs, CTs, relays and carrier blocking signals at the transmission tap location. The Requester will trip their protective device and send a carrier block signal to AEP's remote protective devices for faults on the Requester's tap.
- F) All Requester interconnect facilities shall utilize revenue meters and associated equipment at the Requester's point of connection. For more information on these requirements, reference Appendix E (AEP Metering Requirements for Transmission Interconnection Facilities).
- G) The Requester may be required to purchase and install equipment to shed load during under frequency or under voltage conditions as per RTO/ISO criteria at the Requester's facilities. Please refer to "Automatic Under frequency Load Shedding" in Appendix G.
- H) The Requester shall change their facility or equipment as may be required for AEP to meet future changes in the transmission system including a voltage change or conversion. The Requester is responsible for expenses associated with the change, and shall be given reasonable notice by AEP prior to the date that the required changes to the Requester's facilities need to be made.
- I) AEP shall require dedicated communication facilities be installed, at the Requester's expense, as part of the relay protection, remote monitoring/control and remote metering. Direct voice contact between AEP and the Requester is required for switching. For more detail on these requirements, reference Communication Requirements in Appendix F.
- J) The Requester shall install, operate and maintain in good order and repair, and without cost to AEP, all facilities required by AEP for the safe operation of the Requester's facilities connected to the AEP transmission system. The Requester's facilities shall be installed, operated, and maintained by the Requester at all times in conformity with generally accepted utility practice and shall comply with applicable National Electrical Code, the National Electrical Safety Code, local codes, NERC Reliability Standards, Regional Entities' reliability standards and AEP service standards included in the Interconnection Agreement (IA) or Interconnection and Local Delivery Service Agreement (ILDSA). Electrical facilities operated as a part of the transmission grid shall have the ownership and maintenance responsibility outlined in the IA or ILDSA.
- K) The Requester is solely responsible for providing adequate protection for its interconnecting facilities in such manner that faults or other disturbances on the AEP system do not cause damage to the Requester's equipment. Please refer to Appendix G for details.
- L) The Requester may not connect to the transmission system until consent has been given by AEP. AEP reserves the right to inspect the Requester's facility and witness testing of equipment or devices associated with the interconnection. Additional operating procedures may be developed and included in the IA or ILDSA.
- M) Requester shall install protective devices (relays, circuit breakers, etc.) for the protection of the transmission system and metering equipment as required by AEP. The protective devices of the installing party (AEP or Requester) may differ between installations. The protective device types and schemes to be used must be agreed upon by both the Requester and AEP prior to the design stage.
- N) The Requester shall submit one-line drawings of their equipment to AEP for review of the protective, metering and remote monitoring/control functions. Changes required by AEP shall be made prior to final issue and AEP shall be provided with final copies of the revised drawings.
- O) AEP will review only the portions of the drawings that apply to protection, metering and remote monitoring/control which affect the transmission system. To aid the Requester, AEP may make suggestions on other areas, but will not assume responsibility for the correctness of protection pertaining to Requester's system.
- P) Reference other substation and transmission requirements in Appendix H.

 AMERICAN ELECTRIC POWER <small>BOUNDLESS ENERGY™</small>	<u>TRANSMISSION PLANNING GUIDELINE</u> Requirements for Connection of New Facilities or Changes to Existing Facilities Connected to the AEP Transmission System	Rev. 2	TP-0001
			Page 43 of 99

4.2 General Operating Requirements

The Requester is solely responsible for proper coordination of its equipment with the transmission system and shall provide to AEP for review, the most current specifications for interconnection equipment, including drawings and one-line diagrams. AEP's review of Requester specifications shall not be construed as confirming or endorsing the design or as a warranty of safety, durability or reliability of the facility or equipment.

The Requester's interconnection equipment shall not cause objectionable interference with the electric service provided to other customers. The Requester's equipment shall meet the following criteria:

4.3 Power Factor

The Requester shall not place any undue burden on the AEP transmission system with respect to reactive power and shall operate its equipment in accordance with any applicable power factor requirements as specified in the IA or ILDSA.

The NERC Planning Standards state that distribution entities and customers connected directly to the transmission system should plan and design their systems to operate at "close to unity power factor" to minimize the reactive power burden on the transmission system. AEP interprets "close to unity power factor" to mean that the connected load should not fall below a 0.99 lagging power factor. Power factor penalties are applied based on local jurisdictional terms and conditions.

Switched shunt capacitors generally provide an effective means of controlling the power factor of a Requester's facility. However, there are several factors that should be addressed in applying capacitors. These factors can include, but are not limited to, transient voltages due to capacitor switching and voltage amplification due to resonance conditions. The services of a qualified consultant should be obtained by the Requester to review the specific application and provide recommendations in regard to control of these phenomena.

4.4 Power Quality Requirements

The Requester shall not cause excessive voltage flicker or harmonic waveform distortion on the AEP transmission system. The Requester shall adhere to the power quality requirements outlined in Appendix A (AEP Power Quality Requirements).

4.5 Under frequency Load Shedding

The Requester shall install under frequency relays and shed load as outlined in the applicable RTO/ISO Load Shedding Guides.

4.6 Load Connection Definitions and Requirements

4.6.1 Radial Load Connection Definition and Requirements

A radial connection is capable of receiving power from only one direction. If the Requester's facilities are located near an existing AEP station, the connection from the AEP transmission system may be provided by constructing a radial line from the AEP station to the Requester's facility. If the Requester's facilities are located near an existing AEP transmission line, the connection from the AEP transmission system may be provided by tapping the nearby AEP line and constructing a radial line to the Requester's facility. This arrangement provides a radial connection to the Requester and requires additional in-line facilities at the tap point. Figures 1 and 2 in Appendix B illustrate some of the basic connection configurations and requirements for facilities below 200 kV when the new facilities to the Requester's location are owned by AEP.

Line and Tap switches are typically the minimum requirements at the tap location point. The line switches must meet or exceed the thermal capability of the line conductor. The line switches must also be designed to provide appropriate "Line Dropping" or "Loop Interrupting" capabilities

Wave traps may be required with radial load connections. Carrier signals can be degraded by transformers and/or tapped loads that are electrically located at multiples of the quarter wavelength of the carrier frequency on the line. It is not practical to

 AMERICAN ELECTRIC POWER BOUNDLESS ENERGY™	TRANSMISSION PLANNING GUIDELINE Requirements for Connection of New Facilities or Changes to Existing Facilities Connected to the AEP Transmission System	Rev. 2	TP-0001
			Page 44 of 99

CAUTION: Printed copies of this document are uncontrolled and may be obsolete.
Always check for the latest revision prior to use.

accurately predict in advance whether newly tapped load will create this condition. The Requester will be responsible for costs necessary to ensure that the new delivery point does not degrade the power line carrier signal(s) or protection scheme. This may require installation of a wave trap tuned to the carrier frequency on the appropriate phase at the point of connection. The Requester can choose to install this wave trap in advance, or wait to determine whether a wave trap is necessary at the time of energizing the newly tapped station. However, if the Requester elects not to install the wave trap in advance, and it is later determined that the new installation has degraded the carrier signal(s), then the delivery point will be de-energized until such time that a wave trap is installed to eliminate the source of carrier signal degradation.

Circuit Breakers will be required at the point of connection owned by the Requester. AEP's protection interface will be determined on a case-by-case basis and results included in the IA or ILDSA, as needed. Remote relay panels and carrier equipment may require replacement to properly coordinate the protective schemes.

4.6.2 Looped Load Connection Definition and Requirements

A looped connection is capable of receiving power from two (or more) directions. Looped connections result in fewer and/or shorter outages to the load served at the Point of Delivery. Looped connections have specific design and operational requirements that may differ from radial connections.

Figure 3 in Appendix B (Typical Transmission Tap Supply & Line Looped Supply Configurations) illustrates typical looped supply configurations for connections below 200 kV and some of the basic connection requirements. Other possibilities exist depending on the particular situation.

There are two options for providing an EUC Requester with a looped connection. Circuit breakers or switches (manual or motor operated) can be installed adjacent to the connection. Reference Appendix H (Transmission Switching Guidelines for In-Line Stations) to determine if circuit breakers or switches are required.

Switches (with or without supervisory control) may be required to minimize the outage time of the transformer for the failure of an associated AEP supply line. The in-line switches must meet or exceed the thermal capability of the line conductor. The line switches must also be designed to provide appropriate "Line Dropping" and/or "Loop Interrupting" capabilities.

When the guidelines in Appendix H specify that circuit breakers are required, the connection may benefit from redundant transmission sources. The installation of circuit breakers may require upgrading or replacing relay panels and communications equipment at remote ends of the line.

Connection to the AEP EHV transmission system (200 kV and above) will be reviewed on a case-by-case basis.

4.7 Transmission Line Design, Loading, Clearance, Insulation and Structural Design Requirements

Upon determination of the point of connection, the design and construction of new transmission line facilities on the AEP system necessary to connect the Requester's facilities shall be in accordance with the following criteria:

4.7.1 New Transmission Lines Serving only the Requester and not Owned by AEP

New transmission lines that are "taps" of existing transmission circuits and that are built solely to serve the Requester or do not otherwise involve carrying services to other customers or delivery points and will not be owned by AEP, require the Requester to install breakers, protection, and

 AMERICAN ELECTRIC POWER BOUNDLESS ENERGY™	TRANSMISSION PLANNING GUIDELINE Requirements for Connection of New Facilities or Changes to Existing Facilities Connected to the AEP Transmission System	Rev. 2	TP-0001
			Page 45 of 99

CAUTION: Printed copies of this document are uncontrolled and may be obsolete.
Always check for the latest revision prior to use.

control for all Requester-owned facilities, and may be built to any criteria determined by the facility owner and operator so long as it meets the minimum requirements of:

- A) ANSI-C2, National Electrical Safety Code (NESC), latest edition
- B) NFPA 70, National Electrical Code (NEC), latest edition
- C) Governmental agencies as needed to obtain permits to construct the line (U.S Army Corps of Engineers, FAA, etc.)
- D) Any additional applicable state and local code or criteria.

The facilities must be designed, built, operated, and maintained to perform equivalent or superior to AEP-owned facilities in that region.

4.7.2 New Transmission Lines Serving the Requester and Integrated into the AEP Network

New transmission lines that involve carrying AEP services to more than one customer, or that will be owned or maintained by AEP shall, in addition to the criteria indicated above, be designed in accordance with AEP System Standard TLES-10 (Clearances, Mechanical Loadings and Load Factors Applicable to Structures, Foundations Hardware, Insulators, Conductors, Ground Wire and Line Design) and shall be constructed with AEP standard materials.

4.8 Information Required from End-User

As soon as available, the Requester shall provide two copies of the following information for review and comment by both the Transmission Asset Management and the Transmission Project Engineering departments at AEP.

The following information is a supplement to the issued IA or ILDSA, and the documented tariff details for each of AEP's operating companies.

- A) Requester's Information - company name, mailing address and contact representative's name, phone number and email address.
- B) Project Design/Engineering Information - company name, mailing address and contact representative's name, phone number and email address.
- C) Requested in-service date for the transmission connection, and a date for temporary service to test facilities prior to commercial in-service.
- D) Plot plan or description showing exact location and orientation of Requester's proposed facilities and point of electric service delivery.
- E) One-line, schematic diagrams, plan and elevation drawings of the proposed facilities showing dimensions, clearances and grounding layout.
- F) Information on characteristics of load, including initial load build-up, 5- and 10-year load projections, power factor and load factor of such loads.
- G) Information concerning the Requester's power factor correction equipment. This information should include size and amount of fixed or switched capacitors, or other power factor correction equipment and methods used for operation.
- H) Data on equipment to be installed
 - 1) High-side interrupting and sectionalizing devices - Manufacturer, type, voltage rating, and current rating
 - 2) High-side relaying equipment - Complete manufacturer's data
 - 3) Two- and Three-Winding Power transformers - Manufacturer nameplate, serial number, available voltage taps, MVA ratings, high and low winding connections, low-side grounding (if used), and impedance test report data that includes: percent impedance for both positive and zero sequence (primary-secondary1, primary-secondary2, secondary1-secondary2).
- I) Data on Requester's low voltage protection equipment including fuses, breakers, relays, and relay settings.

 AMERICAN ELECTRIC POWER BOUNDLESS ENERGY™	TRANSMISSION PLANNING GUIDELINE Requirements for Connection of New Facilities or Changes to Existing Facilities Connected to the AEP Transmission System	Rev. 2	TP-0001
			Page 46 of 99

The information listed in Section 4.8 bullets “H” and “I” is required to perform coordination selectivity studies in a timely manner. Any disagreement in this regard must be resolved prior to energization.

Depending upon the nature of the Requester’s equipment to be installed, the following data may be required to complete the portion of the system impact studies addressing power quality and/or sub-synchronous torsional interactions:

- a) Data on the harmonic and sub-harmonic current/voltage spectra of the Requester’s equipment to be installed under three-phase balanced and unbalanced conditions.
- b) Maximum magnitudes (MW and MVAR) of sudden load swings at the point of common coupling and the number of such fluctuations per second, minute or hour
- c) Data on SVC (other FACTS or similar devices) and harmonic filters, if applicable.
- d) Maximum expected MW and MVAR demand at the point of connection.
- e) Modeling data must be supplied to AEP and/or the RTO/ISO to allow necessary interconnection studies to be performed. It is recognized that some of this data may initially be preliminary in nature. Interconnection studies will be based on data submitted. Changes or modifications to this data after the interconnection study has been completed may render the analysis invalid and require re-opening of the interconnection study. It is the End User Connection Requester’s responsibility to make AEP and / or the RTO/ISO aware of changes to this data, and to provide final certified test reports and modeling data as soon as it is available.

4.9 Ownership, Cost, Maintenance and Compliance Responsibility

The Requester shall install, operate and maintain in good order and repair, and without cost to AEP, all facilities required by AEP for the safe operation of the Requester’s facilities connected to AEP’s electrical system. The Requester’s electrical facility shall be installed, operated, and maintained by the Requester at all times in conformity with good utility practice, National Electrical Safety Code, RTO/ISO requirements, NERC Reliability Standards, National Electric Code, and applicable laws and regulations. Any electrical facility operated as a part of the transmission grid shall have the ownership, cost, maintenance and NERC and RTO/ISO compliance responsibilities outlined in the IA or ILDSA.

4.10 Metering/SCADA

Reference Appendix E and Appendix F for Metering, SCADA and Communication Requirements.

4.11 Voice Communications

Voice communications satisfactory to AEP shall be installed and maintained by Requester per requirements of the RTO/ISO, operating company, transmission company, or applicable agreement. Examples of voice communications include a dedicated Voice Dispatch Circuit and connections to the public telephone network. For more detail on these requirements, reference Appendix E and Appendix F.

	TRANSMISSION PLANNING GUIDELINE Requirements for Connection of New Facilities or Changes to Existing Facilities Connected to the AEP Transmission System	Rev. 2	TP-0001
			Page 47 of 99

CAUTION: Printed copies of this document are uncontrolled and may be obsolete.
Always check for the latest revision prior to use.

APPENDIX A

A: AEP Power Quality Requirements

	<p><u>TRANSMISSION PLANNING GUIDELINE</u> Requirements for Connection of New Facilities or Changes to Existing Facilities Connected to the AEP Transmission System</p>	Rev. 2	TP-0001
			Page 48 of 99

AEP Power Quality Requirements

This document summarizes the AEP policy on power quality requirements, which includes voltage flicker, harmonic distortion and other factors, for customers connected to the AEP transmission system. The term Customer is defined as the party connected to the AEP System.

POINT OF COMPLIANCE

The point where the Customer connects to the Company system will be the point where compliance with AEP power quality requirements is evaluated.

VOLTAGE FLICKER CRITERIA

The random voltage fluctuations (flicker) occurring at the Compliance Point directly attributable to the Customer shall remain within the limits specified in IEEE Standard 1453-2004, "IEEE Recommended Practice for Measurement and Limits of Voltage Fluctuations and Associated Light Flicker on AC Power Systems." These limits are 0.8 and 0.6 for the P_{ST} (short term) and P_{LT} (long term) flicker measures, respectively. P_{ST} is the standard reading of a flicker meter, obtained for each 10-minute interval; P_{LT} is derived mathematically (cube root-mean-cube) from twelve consecutive P_{ST} readings (see Exhibit 1).

The Customer agrees that under no circumstances will it permit the voltage flicker to exceed the Company criteria, whether or not complaints are received or service/operational problems are experienced on the Company sub-transmission or transmission system. Should complaints be received by the Company or other operating problems arise, or should the Customer flicker exceed the Company criteria, the Customer agrees to take immediate action to reduce its flicker to a level at which flicker complaints and service/operational problems are eliminated.

Corrective measures could include, but are not limited to, modifying production methods/ materials or installing, at the Customer's expense, voltage flicker mitigation equipment such as a static var compensator. The Company will work collaboratively with the Customer to assess problems, identify solutions and implement mutually agreed to corrective measures.

If the Customer fails to take corrective action after notice by the Company, the Company shall have such rights as currently provided for under the RTO/ISO OATT, which may include discontinuing service, until such time as the problem is corrected.

HARMONIC DISTORTION CRITERIA

The Company also requires that the Customer's operation be in compliance with the Company's Harmonic Distortion Guidelines (see Exhibit 2). These requirements are based on IEEE Standard 519, "IEEE Recommended Practices and Requirements for Harmonic Control in Electric Power Systems".

The Customer agrees that the operation of motors, appliances, devices or apparatus served by its facility that result in harmonic distortions in excess of the Company's Requirements will be the Customer's responsibility to remedy immediately, at the Customer's expense, in order to comply with the Company's Harmonic Distortion Requirements. The Company will work collaboratively with the Customer to assess problems, identify solutions, and implement mutually agreed to corrective measures.

If the Customer fails to take corrective action after notice by the Company, the Company shall have such rights as currently provided for under the RTO/ISO OATT, which may include discontinuing service, until such time as the problem is corrected.

While IEEE Standard 519-1992 recommends that even-numbered harmonic currents be limited to only 25% of the stated values, the requirements established herein are uniform at the full-limit values for both odd and even harmonics. AEP reserves the right to limit the even harmonic currents, as recommended by IEEE Standard 519-1992, if operational problems and/or customer complaints are experienced in the future.

 AMERICAN ELECTRIC POWER BOUNDLESS ENERGY™	<u>TRANSMISSION PLANNING GUIDELINE</u> Requirements for Connection of New Facilities or Changes to Existing Facilities Connected to the AEP Transmission System	Rev. 2	TP-0001
			Page 49 of 99

COMMUNICATION INTERFERENCE

The total communication interference (I*T product) shall not exceed the level of weighted Amperes, at the Compliance Point, prescribed by IEEE Standard 519-1992 (see Exhibit 2).

OTHER REQUIREMENTS

A. Electrical Interactions

If Power Quality Compliance Monitoring recordings or analytical studies conducted by AEP indicate likely adverse electrical interactions (e.g., resonance) between the connected facility and the AEP System, joint efforts will be undertaken by AEP and the customer to determine the nature and extent of the electrical interaction and to resolve, at no expense to AEP, any likely adverse impacts on the performance of AEP facilities.

B. Compliance Assessment

To achieve compliance, at least 95% of all recordings within each harmonic measure and 99% within each flicker measure must fall below the applicable limit, i.e., the customer will be in material non-compliance with the AEP Power Quality Requirements if more than 5% of the harmonic voltage and harmonic current recordings and 1% of the flicker recordings exceed the specified limits.

EXHIBIT 1

AEP VOLTAGE FLICKER REQUIREMENTS

[Based on IEEE Standard 1453-2004, "IEEE Recommended Practice for Measurement And Limits of Voltage Fluctuations and Associated Light Flicker on AC Power Systems"]

Voltage Flicker Measure	Maximum Value
P _{ST} (Short Term)	0.8
P _{LT} (Long Term)	0.6

EXHIBIT 2

AEP HARMONIC DISTORTION REQUIREMENTS

[Extracted from IEEE/ANSI Standard 519-1992, "IEEE Recommended Practices and Requirements for Harmonic Control in Electric Power Systems."]

HARMONIC VOLTAGE DISTORTION (THD_V) LIMITS

[Applicable to Transmission Systems]

Bus Voltage at PCC	Individual Harmonic Voltage Distortion (%)	Total Voltage Distortion THD _V (%)
≤ 69 kV	3.0	5.0
> 69 kV and ≤ 161 kV	1.5	2.5
> 161 kV	1.0	1.5

HARMONIC CURRENT DEMAND DISTORTION (TDD) LIMITS

[Applicable to Individual Customers at the Point of Common Coupling (PCC)]

Maximum Harmonic Current Distortion in Percent of Base Quantity Harmonic Order (Odd Harmonics)						
V ≤ 69 kV						
<i>I_{sc}/I_L</i>	< 11	11 ≤ h < 17	17 ≤ h < 23	23 ≤ h < 35	35 ≤ h	TDD
<20*	4.0	2.0	1.5	0.6	0.3	5.0
20<50	7.0	3.5	2.5	1.0	0.5	8.0
50<100	10.0	4.5	4.0	1.5	0.7	12.0
100<1000	12.0	5.5	5.0	2.0	1.0	15.0
>1000	15.0	7.0	6.0	2.5	1.4	20.0
69 kV < V ≤ 161 kV						
<20*	2.0	1.0	0.75	0.3	0.15	2.5
20<50	3.5	1.75	1.25	0.5	0.25	4.0
50<100	5.0	2.25	2.0	0.75	0.35	6.0
100<1000	6.0	2.75	2.5	1.0	0.5	7.5
>1000	7.5	3.5	3.0	1.25	0.7	10.0
161 kV < V						
<50	2.0	1.0	0.75	0.3	0.15	2.5
≥50	3.0	1.5	1.15	0.45	0.22	3.75
Even harmonics are limited to 25% of the odd harmonic limits above.						
* All power generation equipment is limited to these values of current distortion, regardless of actual <i>I_{sc}/I_L</i> .						
where <i>I_{sc}</i> = Maximum short-circuit current at PCC. <i>I_L</i> = Load current (fundamental frequency component) at time of maximum metered amount at PCC.						



Definitions

- Harmonic Voltage Distortion is to be normalized to the nominal system voltage and calculated using Equation 1

TOTAL VOLTAGE HARMONIC DISTORTION (THD_V) in percent:

$$\text{THD}_V = \frac{\sqrt{\sum_{n=2}^{\infty} V_n^2}}{V_s} \times 100\% \quad (\text{Eq. 1})$$

Where:

V_n = Magnitude of Individual Harmonics (RMS)
V_s = Nominal System Voltage (RMS)
n = Harmonic Order

- Harmonic Current Distortion is to be normalized to the customer's load current at the time of the maximum metered demand which occurred over the preceding twelve months for existing customers and the customer's anticipated peak demand for new customers. For existing customers who are increasing their load, the projected demand should be used. The harmonic current demand distortion (TDD) should be calculated using Equation 2.

TOTAL CURRENT DEMAND DISTORTION (TDD) in percent:

$$\text{TDD} = \frac{\sqrt{\sum_{n=2}^{\infty} I_n^2}}{I_L} \times 100\% \quad (\text{Eq. 2})$$

Where:

I_n = Magnitude of Individual Harmonic (RMS)
I_L = Load current at the time of the maximum metered demand
n = Harmonic Order

- PCC – Point of Common Coupling is the location where the customer accepts delivery of electrical energy from the utility.

Field Measurements

To gauge the acceptability of field measured harmonic distortion, a statistical evaluation of the data is to be performed. Measurements should be taken at five minute intervals or less over a minimum of 24 hours. For the measured data to be considered acceptable, two criteria must be met: 1) 95% of the measured data must fall below the limits stated; and 2) no measure data shall exceed the limits specified by than 50% of the absolute upper limit value.

COMMUNICATION INTERFERENCE LIMITS (I*T)

Rather than provide specific limits on I*T values, due to the limitations involved, IEEE/ANSI standard 519 outlines the ranges of I*T values for three potential states of telephone interference inflicted by the harmonic components of current and voltage, which are shown in the table below. The actual interference to voice communication systems in proximity to the power system is dependent upon a number of factors not under the control of the utility or customer. These factors will vary from location to location and from time to time as the state-of-the-art of inductive coordination progresses.

 AMERICAN ELECTRIC POWER BOUNDLESS ENERGY™	<u>TRANSMISSION PLANNING GUIDELINE</u> Requirements for Connection of New Facilities or Changes to Existing Facilities Connected to the AEP Transmission System	Rev. 2	TP-0001
			Page 52 of 99

IEEE STANDARD 519 – BALANCED I*T GUIDELINES

Category	Description	I*T
I	Levels most unlikely to cause interference	< 10,000
II	Levels that might cause interference	10,000 to 25,000
III	Levels that probably will cause interference	> 50,000

The limit applicable to AEP is the upper bound limit of the I*T levels that might cause interference on telephone systems. Thus, the customer induced harmonics shall not result in an I*T product to exceed 25,000 weighted amperes per phase, applicable to both the transmission and distribution systems. Residual I*T should also be minimized. Residual I*T is $I_G * T$, where I_G is the earth return current and is defined as the difference between the phasor sum of phase currents and neutral current. The I*T calculation is to be performed using Equation 3. The weighting of harmonic currents should conform to the 1960 TIF data shown in the table below.

I*T PRODUCT in amperes:

$$I*T = I*TIF = \sqrt{\sum_{n=1}^K (I_n * W_n)^2} \text{ weighted amperes (Eq. 3)}$$

Where:

I = Current of individual harmonics, RMS

T = Telephone Influence Factor (TIF)

W_n = Single frequency TIF weighting at frequency n (refer to tables below)

$K \leq 42$, Maximum harmonic order

Frequency	W_n
60	0.5
180	30
300	225
360	400
420	650
540	1320
660	2260
720	2760
780	3360
900	4350
1000	5000

Frequency	W_n
1020	5100
1080	5400
1140	5630
1260	6050
1380	6370
1440	6650
1500	6680
1620	6970
1740	7320
1800	7570

Frequency	W_n
1860	7820
1980	8330
2100	8830
2160	9080
2220	9330
2340	9840
2460	10340
2580	10600
2820	10210
2940	9820

Frequency	W_n
3000	9670
3180	8740
3300	8090
3540	6730
3660	6130
3900	4400
4020	3700
4260	2750
4380	2190
5000	840

APPENDIX B

B: Connection Diagrams

Note that RTOs may also have minimum design requirements, which may be more restrictive than AEP in some circumstances. It is the responsibility of the Requester to validate that both RTO and AEP requirements are met and/or exceeded.

Not all equipment or options are shown. AEP reserves the right to specify the final acceptable configuration with consideration to future expansion and compliance requirements. Acceptable configurations may vary by voltage class.

Figure 1 Appendix B Figure Legend

Typical Transmission End-User Supply Configurations

- Figure 2 End-User Connection Types A, B, and C
- Figure 3 End-User Connection Types D, E, and F
- Figure 4 End-User Connection Type G

Typical Transmission Interconnection Configurations

Transmission Interconnections are typically handled on a case-by-case basis and therefore no figures are included.

Typical Generation Connection Configurations

- Figure 5 Generation Connection Types A, B, and C
- Figure 6 Generation Connection Types D and E
- Figure 7 Generation Connection Type F

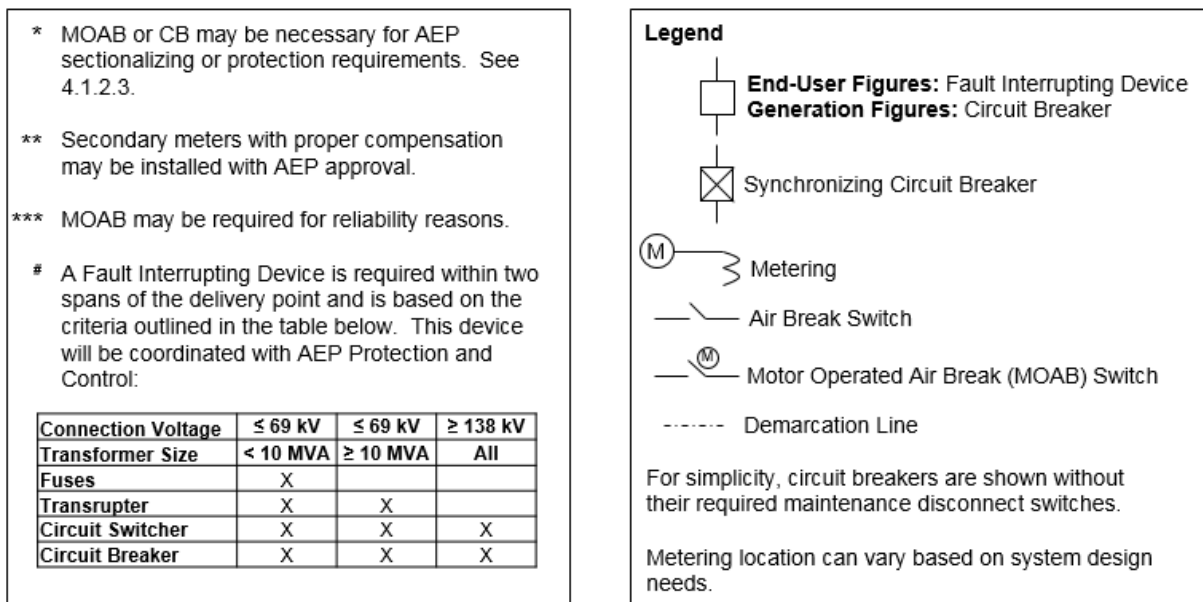

Figure 1: Appendix B Figure Legend

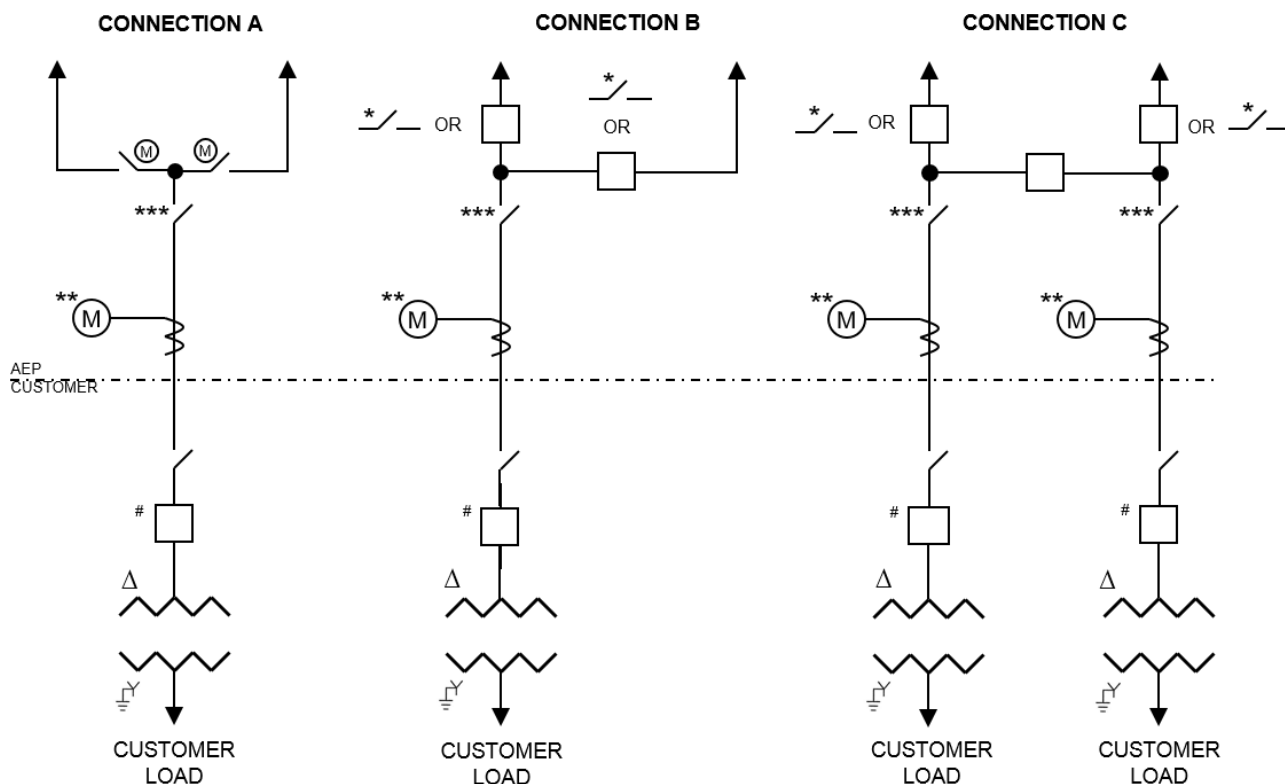

Figure 2: End-User Connection Types A, B, and C

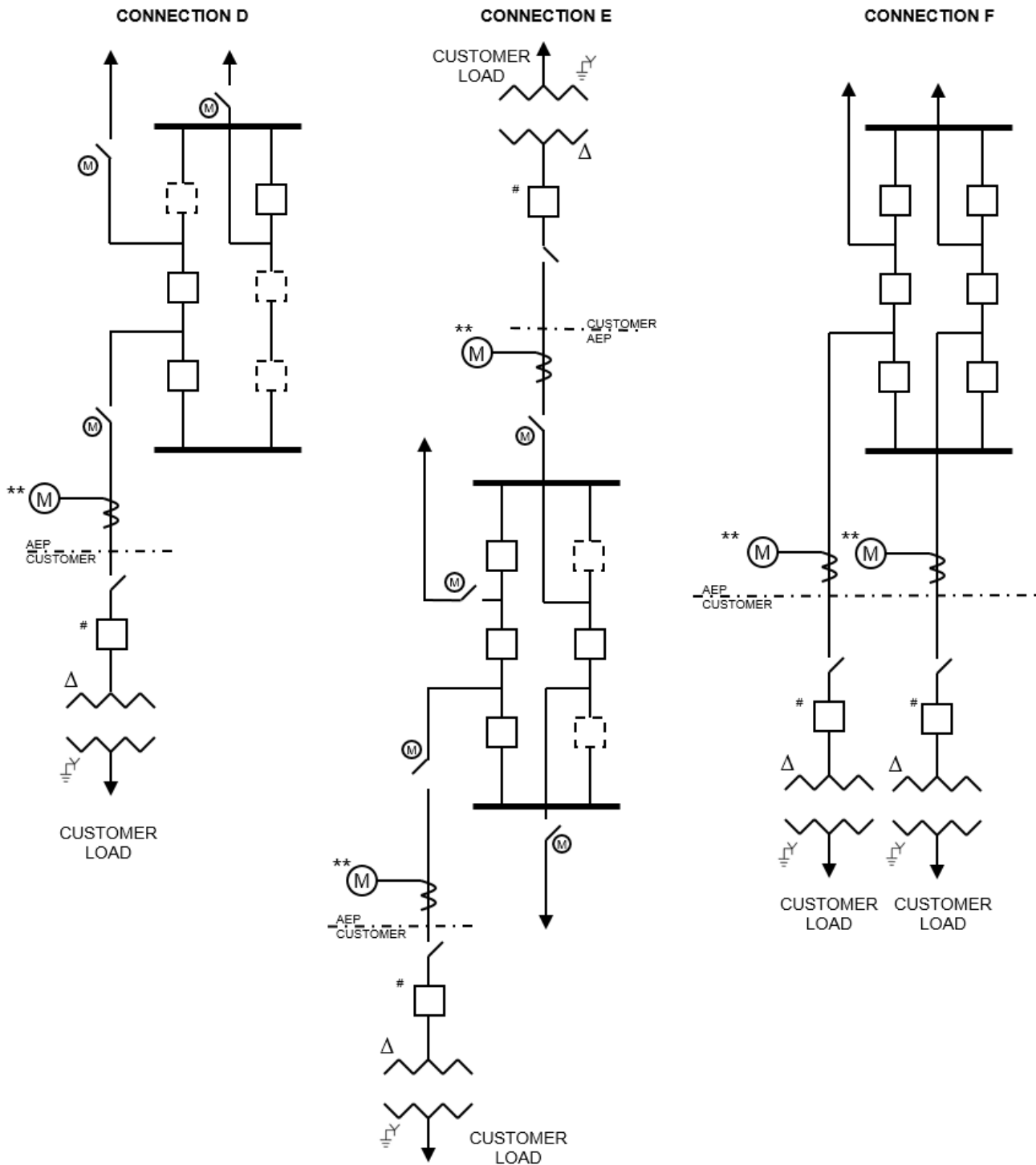

Figure 3: End-User Connection Types D, E, and F

CONNECTION G

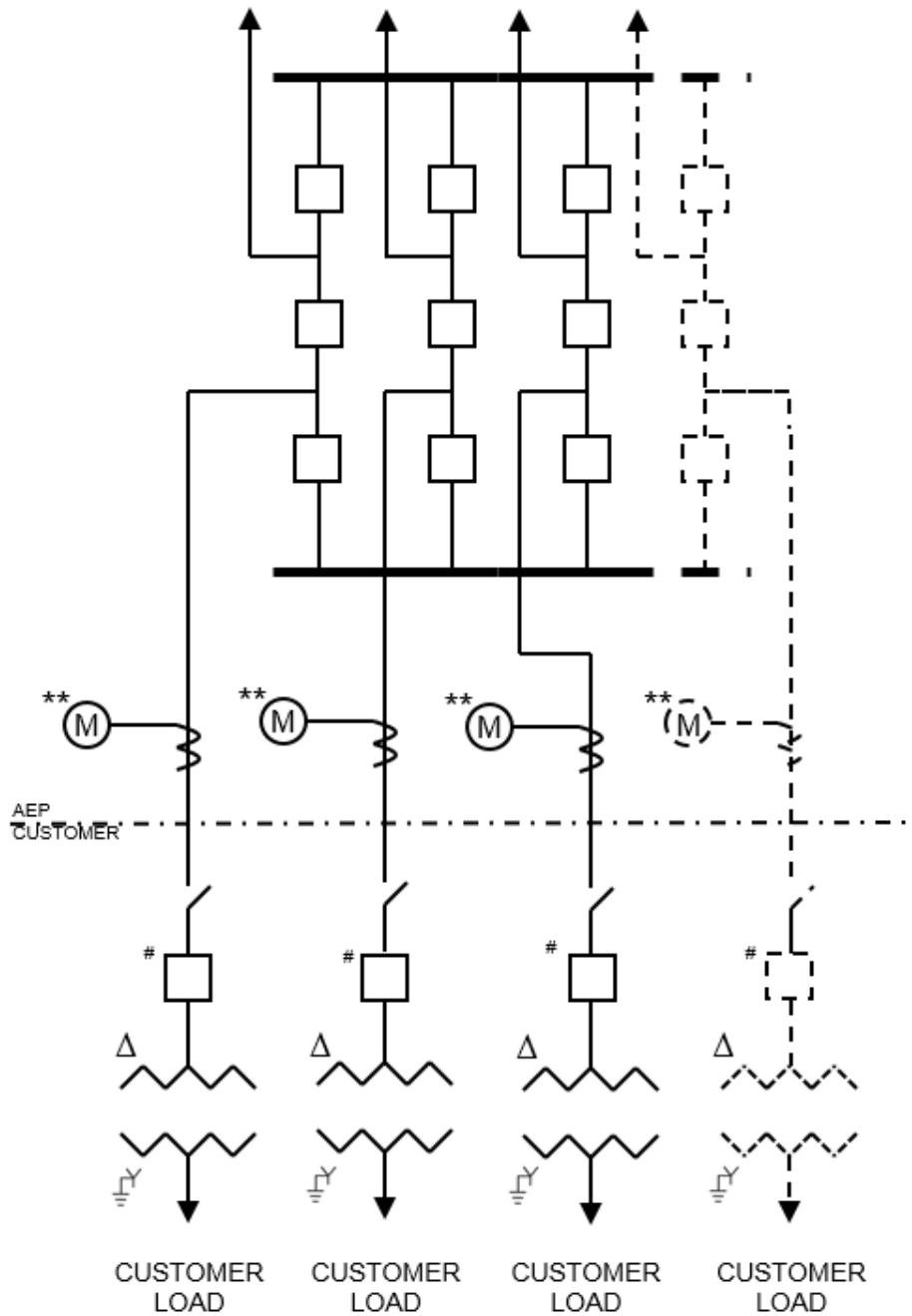

Figure 4: End-User Connection Type G

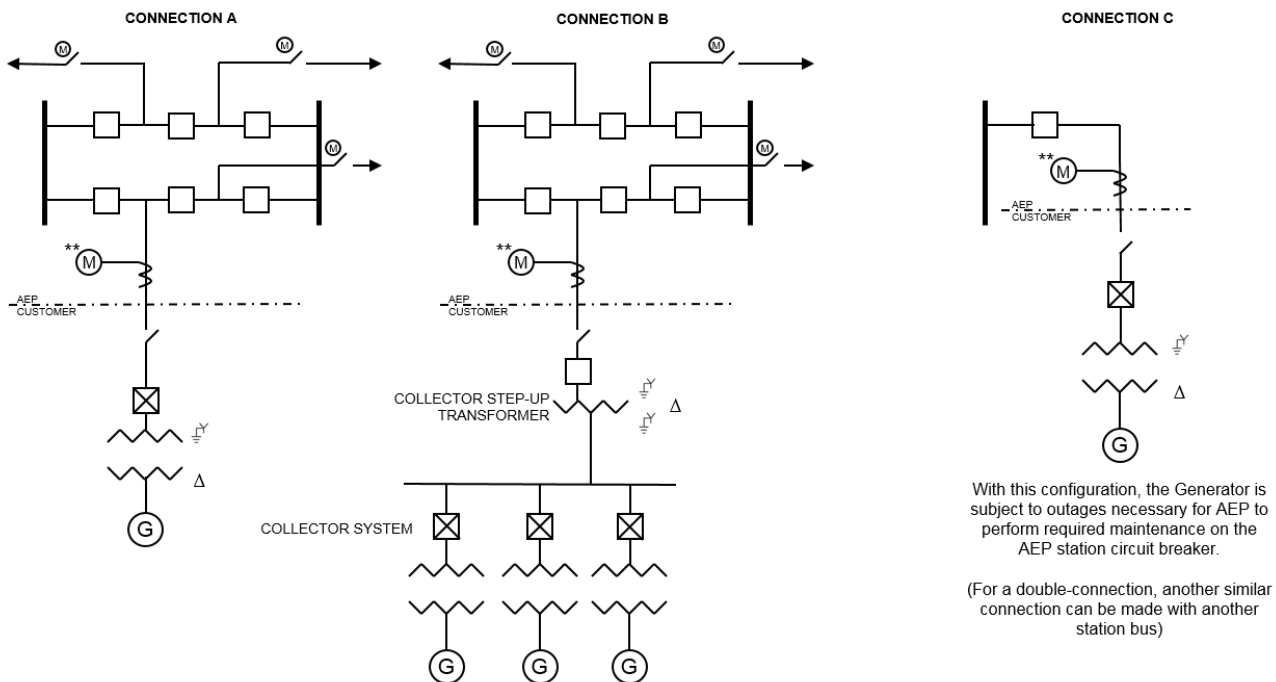

Figure 5: Generation Connection to an Existing Station Bus

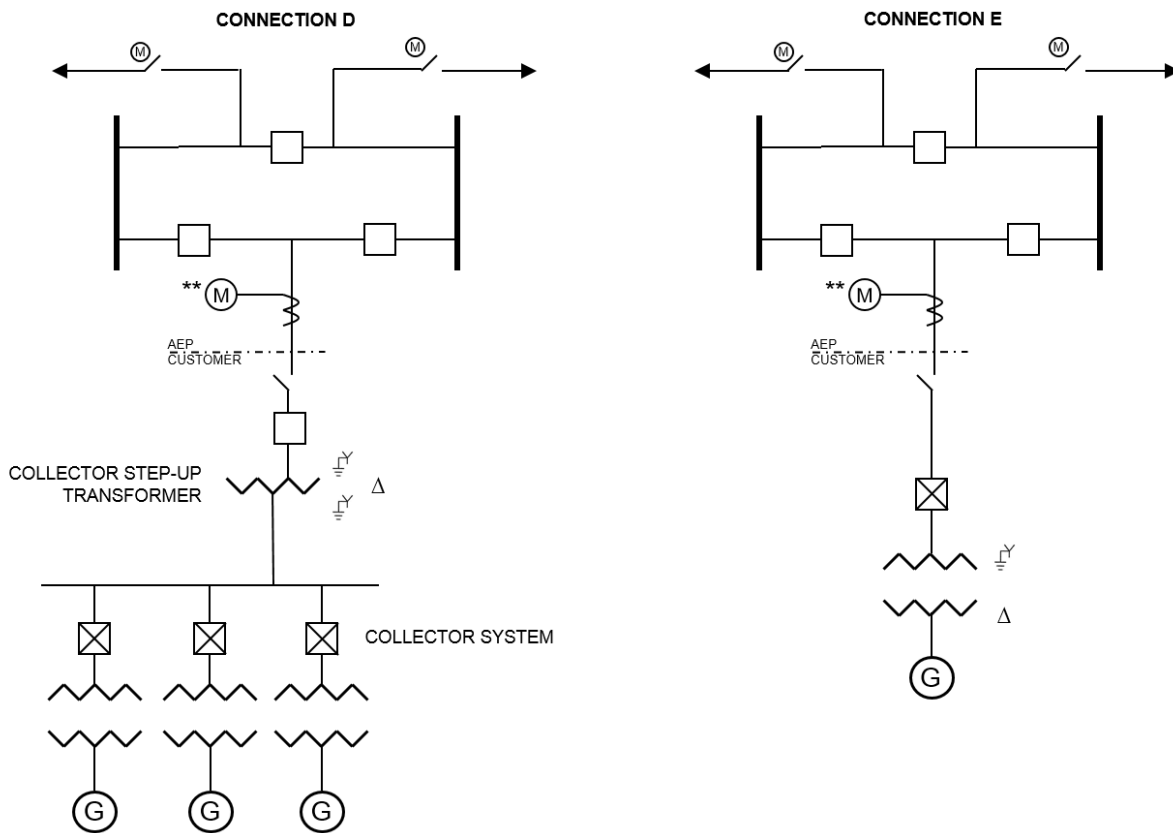

Figure 6: Generation Connection to an Existing Transmission Line

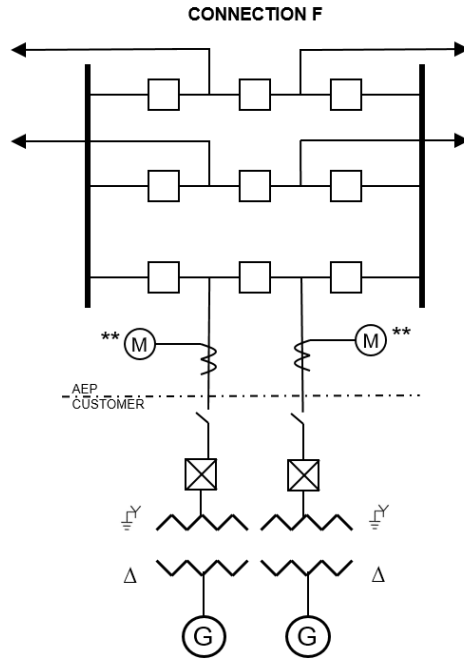



Figure 7: Generation Double Connection to an Existing Line(s)

APPENDIX C

C: Electrical Clearances and Equipment Ratings

 <p>AMERICAN ELECTRIC POWER <small>BOUNDLESS ENERGY™</small></p>	<p><u>TRANSMISSION PLANNING GUIDELINE</u> Requirements for Connection of New Facilities or Changes to Existing Facilities Connected to the AEP Transmission System</p>	<p>Rev. 2</p>	<p>TP-0001</p> <hr/> <p>Page 60 of 99</p>
--	---	-------------------	---

ELECTRICAL CLEARANCES

Nominal System Voltage (kV)	Basic Impulse Insulation Level (BIL) (KV crest) (2)		Outdoor Design Clearance (in.)				Air Insulated Switch Design Clearance (in.)		Station Post Insulators Technical Reference Number(1)(2)
	Bus & Transformer Winding	Transformer Bushing	Centerline-Ground		Centerline-Centerline		Air Break	Disconnect	
			Rigid Bus	Strain Bus	Rigid Bus	Strain Bus	Phase Spacing	Phase Spacing	
765	2050	2050	195	240	390	480	480	390	n/a
500	1550	1550	147	180	270	300	300	270	379
345	1050	1050	99	132	150	180	216	150	316
230	900	900	84	120	124	164	192	124	304,308
161	750	750	63	86	86	116	168	86	291,295
138	550	650	46	60	72	84	144	72	286,287
88	450	550	37	44	54	60	108	54	286,287
69	350	350	29	36	42	48	84	42	216
46	250	250	21	24	36	42	72	36	214
34.5	200	200	16	21	30	36	60	30	210
23	150	200	13	18	24	30	60	30	208

(1) The technical reference numbers shown are a widely used identification series for post type insulators and are the AEP standard for the voltage class. Refer to ANSI Standard C29.9-1983, Table 1, for dimensions and characteristics for each insulator. Higher strength insulators with different technical reference numbers are available and should be used if required.
 The ANSI Technical Reference (T.R.) numbers refer to insulators with specific mechanical ratings. Higher ratings may be required or may be adequate according to the duty of the specific application.

(2) Substations in heavily contaminated areas may require a higher insulation level than indicated.

APPENDIX D

D: 800 kV Major Equipment Specifications

 AMERICAN ELECTRIC POWER <small>BOUNDLESS ENERGY™</small>	<u>TRANSMISSION PLANNING GUIDELINE</u> Requirements for Connection of New Facilities or Changes to Existing Facilities Connected to the AEP Transmission System	Rev. 2	TP-0001
			Page 62 of 99

800 kV Equipment Dielectric Withstand Rating						
Equipment Type	60 Hz 1 minute Dry Withstand (kV rms) Closed/Open	BIL 1.2X50 Usec. (kV peak) Closed/Open	CWW 1.2X50 Usec. chopped @ 2Usec. kV Peak Closed/Open	CWW 1.2X50 Usec. chopped @ 3Usec. kV peak Closed/Open	SWW (kV Peak)	
					Closed/Open Wet	Closed/Open Dry
800 kV Circuit Breaker	960 dry	2050/2250	2640	2360	1425/1550	1700/1870
800 kV Current Transformer	960 dry	2050	2640	2360	1550	1700
800 kV Disconnect Switches	850 kV (10sec. Wet)	2050	-	-	1400 (Closed)	1750 (Open)
800 kV CCVT	-	2425	-	2850	1675	-
765 kV Transformer	883 kV (5 sec) 795 kV (1 hr)	2050	-	2260	1450	1700

TECHNICAL REQUIREMENTS OF 800 KV EQUIPMENT

Equipment Type	Max. kV Rating	Nominal kV Rating	Cont. Current	Interrupting Current	Max. Interrupting Time	Minimum Oper. Temp.	Maximum Oper. Temp.	Limit switching Surge level	CT Ratio & Accuracy	CT TRF
800 KV SF6 Dead Tank Circuit Breaker	800 kV	765 kV	3000 A	50/63 kA	2 Cycles	-35 ^o C	>40 ^o C	<1.9 PU	3000/5 C800 @ 2000/5 OR 2000/5 C800 @1200/5	>2

Equipment Type	SA Rating	SA MCOV	FOW Protective Level @ 20 kA	Max. Switching Surge Protective Level @ 2KA	Maximum Discharge kV For 8X20 Usec 3 kA	Maximum Discharge kV For 8X20 Usec 10 kA	Maximum Discharge kV For 8X20 Usec 20 kA	Maximum Discharge kV For 8X20 Usec 40 kA	Leakage Distance Inches
800 kV Metal Oxide Surge Arrester	588 kV RMS	476 kV RMS	<1620 kV Crest	<1200 kV Crest	<1240 kV Crest	<1340 kV Crest	< 1420 kV Crest	<1570 kV Crest	> 620 inches

APPENDIX E

E: AEP Metering Requirements for Transmission Interconnection Facilities

(NOTE: This Appendix is an AEP Standard and is included for reference. The requestor should obtain the latest copy from AEP at the time of request)

 AMERICAN ELECTRIC POWER <small>BOUNDLESS ENERGY™</small>	TRANSMISSION PLANNING GUIDELINE Requirements for Connection of New Facilities or Changes to Existing Facilities Connected to the AEP Transmission System	Rev. 2	TP-0001
			Page 65 of 99

AEP METERING REQUIREMENTS FOR TRANSMISSION INTERCONNECTION FACILITIES

TABLE OF CONTENTS

PURPOSE	66
SCOPE	66
REFERENCES	67
REVISION HISTORY	67
METERING	67
General	67
Metering Standard Requirements	68
Metering Equipment Maintenance and Testing.....	69
Current Transformer Specifications	69
Voltage Transformer Specifications.....	70
Remote Meter Access and Communications.....	70
Requestor Access to AEP Metering Circuits.....	70

PURPOSE

This document is intended to specify the **American Electric Power (AEP)** metering requirements for transmission interconnection facilities connecting to the AEP transmission system. This document serves as Appendix E to “Requirements for Connection of New Facilities or Changes to Existing Facilities Connected to the AEP Transmission System.” Requestor categories used throughout this document are identified as follows: **Generator Connection (GC) Requester, Transmission Interconnection (TI) Requester, and End-User Connection (EUC) Requester.**

This guide provides Planning Engineers, Project Managers, Asset Management personnel, Design Teams and Field Services personnel with key information for consistent and effective metering of the interconnection. These requirements are vital in ensuring accurate metering of energy at the point of interconnection, and for reliable, cost-effective service of the metering system. This appendix is intended to complement the “Requirements for Connection of New Facilities or Changes to Existing Facilities Connected to the AEP Transmission System” document. This appendix addresses the specific requirements for metering, while the “Requirements for Connection of New Facilities or Changes to Existing Facilities Connected to the AEP Transmission System” document addresses the metering requirements in more general terms.

SCOPE

This document addresses not only the general energy metering requirements, but also addresses specific applications and related issues. However, this document does not address the requirements at a schematic level of detail. Design and testing requirements are addressed for not only metering but also a few schedule coordination and other logistical considerations between the GC, TI or EUC Requester and AEP. This document is applicable for all facilities requesting connection to the AEP transmission system.

REFERENCES

The following AEP Transmission Planning documents were used as starting points for development, and these requirements are compatible with and complement these Planning Guides:

- CSW Guidelines for Generation, Transmission and Transmission Electricity End-Users Interconnection Facilities. March 2000. (Updated to American Electric Power West Guidelines, May 2002).
- AEP Requirements for Connection of Non-Generation Facilities to the AEP transmission system. March, 2000
- AEP Requirements for Connection of Generation Facilities to the AEP Transmission System. May 1999.
- AEP “In-Line” Facility Policy and Guideline for Generation and Non-Generation Transmission Customers. May 2002.

Other References Include:

- SS-451001 AEP Protection and Disturbance Monitoring Requirements for Connecting to the AEP Transmission Grid (Appendix G of “Requirements for Connection of New Facilities or Changes to Existing Facilities Connected to the AEP Transmission System”).
- SS-500000 AEP SCADA RTU Requirements for Transmission Interconnection Facilities (Appendix F of “Requirements for Connection of New Facilities or Changes to Existing Facilities Connected to the AEP Transmission System”).

Standard References Include:

- ANSI C12.1: Code for Electricity Metering
- ANSI C12.7: Requirements for Watt-Hour Meter Socket
- ANSI C12.9: Test Switches for Transformer-Rated Meters
- ANSI C12.11: Instrument Transformers for Revenue Metering, 10kV thru 350kV BIL
- ANSI C12.10: Electromechanical Watthour Meters
- ANSI C12.16: Solid State Electricity Meters
- ANSI C12.20: Electricity Meters 0.2 and 0.5 Accuracy Class
- ANSI C37.90.1: Surge Withstand Capability (SWC) Test
- ANSI/IEEE C57.13: Standard Requirements for Instrument Transformers

REVISION HISTORY

Rev.	Description of Change(s)	By	Date	Approved
0	Original Issue	Dan Recker	1-24-03	DJR
1	Scope section and General section, 3 rd bullet (page 3), and added exemption for AEP-owned Distribution. Clarified “Freeze Signal” section, pg 4. Added a section for special requirements for mine facilities (pg 5).	Dan Recker	4-19-03	DJR
2	Customer Meter Access - Option for shared meter data on meters equipped with hardware security lock	Dan Recker	12-29-03	DJR
3	General Changes	D. Bernert	03-09-07	JAS
4	Added to combined TP-001 document, “Requirements for Connection of New Facilities or Changes to Existing Facilities Connected to the AEP Transmission System”	D. Bernert	09-10-09	DJB

METERING

General

The interconnection energy metering system (metering package) consists of instrument transformers, voltage transformers (VT’s), current transformers (CT’s), energy meters, test switches, and auxiliary equipment if required, in a dedicated metering panel or enclosure.

	TRANSMISSION PLANNING GUIDELINE Requirements for Connection of New Facilities or Changes to Existing Facilities Connected to the AEP Transmission System	Rev. 2	TP-0001
			Page 67 of 99

For two or more points of interconnections (for example, two or more lines) to the AEP transmission grid, independent energy metering shall be installed on each interconnection circuit.

Primary and backup energy meters shall be installed in each transmission interconnection metering circuit.

All metering quantities shall be measured at or, at AEP's option, compensated to the point of interconnection. The application of compensated metering must be reviewed and approved by AEP.

All reasonable costs associated with the initial installation of the metering package or any recurring operation and maintenance charges including changes to and/or upgrades of the metering equipment, shall be borne by the GC, TI or EUC Requester unless this requirement is superseded by regulatory or contractual requirements.

For each metering point, three current instrument transformers (CT's) and three voltage transformers (VT's) are required as the source for metering (three element metering) real and reactive power and energy at the point of interconnection.

For radial interconnections with multiple load centers where the aggregate of all measured energy quantities of the connected facility is required, totalization will be performed by AEP Load Research.

The energy meters shall have programmable transformer and line loss compensation capability. All displayed, recorded, and output energy quantities will represent the compensated quantities. If the energy metering location is different than the contractual point of interconnection, losses shall be compensated in the energy meter to the contractual point of interconnection.

Energy meters shall be programmable and capable of measuring, recording, and displaying bi-directional, four-quadrant, kWh and kVARh energy quantities. The meter(s) shall be capable of storing these quantities as 4 independent 15-minute interval channels for a minimum of 45 days.

Metering circuits shall be properly designed so that power/energy flow from AEP to the GC, TI or EUC Requester will register as kWh "Out" or kWh "Delivered in the energy meters. Likewise, power/energy flow from the GC, TI or EUC Requester to AEP shall register kWh "In" or kWh "Received" in the energy meters. The same conventions will be observed for reactive energy/power.

At a minimum, energy meters shall be capable of displaying the following three phase instantaneous quantities: bi-directional kW, bi-directional kVAR, and kVA. In addition, primary voltage (each phase), primary current (each phase), and system frequency (Hz) shall be displayed.

For generation interconnection metering, all data multipliers (kWh, kVARh, kW, and kVAR) in the energy meter shall be scaled sufficiently to resolve full generator output and minimum backfeed power of the generating plant.

Energy meters shall have at least one RS-485/232 selectable port and one Ethernet port addressable by AEP's RTU and capable of providing bi-directional kWh and kVARh energy counters and all of the above instantaneous values in DNP 3.0 standard protocol. The energy meter shall also have an option available to provide hardwired form C (K-Y-Z) energy pulse contacts for each of the bi-directional kWh and kVARh energy quantities measured, and analog transducers outputs for the kW and kVAR instantaneous quantities measured. In addition, the energy meter shall have an IRIG-B port to allow meter clock time synchronization to a satellite GPS clock.

If practical, CT/VT combination units may be specified. These combination units shall meet the same electrical, accuracy, and mechanical specifications as required for the individual revenue class CT's and VT's.

Energy meters shall be revenue class (0.2% or better). All real time quantities will originate from 0.2 % (or better accuracy specification) metering equipment.

Generation Plant Metering: SCADA metering is required for all generation gross and station use auxiliary circuits connected to the AEP transmission system. All VT's and CT's used for generation Supervisory Control and Data Acquisition (SCADA) or statistical (non-revenue or billing) metering shall conform to relay accuracy class or better unless used for transmission interconnection metering. MW and MVAR transducers shall be 3-element transducers with an accuracy of 0.2% or better.

Metering Standard Requirements

The metering package shall be installed, calibrated, and tested at Requestor's expense in accordance with the latest approved versions of (but not limited to) the Standard References listed above.

To the extent that AEP's requirements regarding interchange metering and transactions conflict with the manuals, standards or guidelines of the applicable RTO/ISO, such RTO/ISO documents shall control.

 AMERICAN ELECTRIC POWER BOUNDLESS ENERGY™	<u>TRANSMISSION PLANNING GUIDELINE</u> Requirements for Connection of New Facilities or Changes to Existing Facilities Connected to the AEP Transmission System	Rev. 2	TP-0001
			Page 68 of 99

AEP shall provide functional specifications and design for the metering at the GC, TI or EUC Requester's facility. The criteria for these functional specifications shall be based on existing AEP energy metering practices and standards. AEP reserves the right to specify the type and manufacturer for all associated revenue metering equipment including the instrument transformers.

Metering Equipment Maintenance and Testing

Unless otherwise specified or superseded by regulatory or Interconnection Agreement requirements, the energy metering shall be inspected and tested at least every two years, and the test results will be available to all involved parties. If the Requester requires additional testing other than the normal test cycle, and the energy metering is found to be within the established tolerances, this additional testing shall be performed at the Requester's expense.

The metering equipment facility shall accommodate 24 hour per day accessibility for AEP personnel without escort from GC, TI or EUC Requester, facility operator, or landowners.

The accuracy of the energy metering package shall be maintained at three tenths of one percent (0.3%) accuracy or better, and the meter test shall require the use of a meter standard with accuracy traceable to the National Institute of Standards and Technology (NIST).

If energy metering equipment fails to function, the energy registration shall be determined from the best available data. This shall include backup metering, check metering, or historical metering data.

If, at any test of metering equipment, an inaccuracy shall be disclosed exceeding the ANSI specification of two percent (2%), the account between the parties for service theretofore delivered shall be adjusted to correct for the inaccuracy disclosed over the shorter of the following two periods: (1) for the 30-day period immediately preceding the day of the test, or (2) for the period that such inaccuracy may be determined to have existed. If terms of an Interconnection Agreement between AEP and the GC, TI or EUC Requester differ from the above criteria, the Interconnection Agreement will take precedence.

Instrument transformers shall be inspected and maintained according to existing AEP practices and standards.

The party that owns the metering equipment shall maintain records that demonstrate compliance with all meter tests and maintenance conducted in accordance with generally accepted utility practice for the life of the interconnection point. The other party shall have reasonable access to the records.

Current Transformer Specifications

For new installations, current transformers shall meet an accuracy class of 0.15S for energy metering. For existing installations, current transformers shall meet or exceed an accuracy class of 0.3 (as defined in latest version of IEEE C57.13).

Current transformers shall comply with the minimum BIL rating as specified in standards IEEE C57.13 and ANSI C12.11. In addition, dielectric withstand levels shall meet AEP's current standard.

The mechanical and thermal short time current ratings of the current transformer shall exceed or withstand the available fault current at the point of connection to the transmission system.

The connected CT secondary burden of the current transformer shall not exceed the CT nameplate burden rating.

Optical CT's, or optical combination CT/VT units shall not be used on AEP transmission energy metering applications where AEP owns or services the equipment. If the GC, TI or EUC Requester installs optical CT's, they shall be tested at a minimum test frequency of five years.

For Generation Interconnection metering, unless otherwise specified, the current and voltage instrument transformers shall be located at the defined point of delivery on the high side of the Generator Step up Transformer (GSU) or Reserve Auxiliary Transformer. CT's shall be appropriately sized for 0.15% accuracy or better over the entire CT secondary current range, including full generator output and, if applicable, the nominal backfeed auxiliary and start-up power. The secondary burden rating of the CT shall be specified to meet all the standard burdens of B0.1 through B1.8. Wide Range/Extended Accuracy current transformers (0.15S) shall be used to meet these requirements. The thermal rating factor (TRF) of the CT's shall be a minimum of 2.0.

For non-EHV (230kV and below) interconnections with two or more points of connection, each interconnecting circuit shall be metered independently with independent CT's to independent metering packages. For interconnections at the EHV level (345kV and above) with single breaker, breaker-and-a-half, and two breaker schemes, BCT's and CCVT's may be used, if allowed by RTO requirements.

	<p><u>TRANSMISSION PLANNING GUIDELINE</u> Requirements for Connection of New Facilities or Changes to Existing Facilities Connected to the AEP Transmission System</p>	Rev. 2	TP-0001
			Page 69 of 99

Voltage Transformer Specifications

Voltage transformers shall meet or exceed an accuracy class of 0.15% (as defined in IEEE C57.13).

An independent 115VAC nominal secondary winding of the voltage transformer shall be dedicated for the energy meter package. Energy meters shall not be connected to the 69VAC nominal secondary winding of the voltage transformer.

The VT connected secondary burden(s) of the voltage transformer shall not exceed the VT nameplate burden rating.

Optical VT's, or optical combination CT/VT units shall not be used on AEP transmission energy metering applications where AEP owns or services the equipment. Coupling Capacitor Voltage Transformers (CCVT's) may be used only in installations where a ferroresonance problem is indicated and at the EHV level (345kV and above) and if RTO metering requirements allow for this arrangement. The CCVT shall meet a minimum accuracy class of 0.15%. If the Requester installs optical VT's or CCVT's, they shall be tested at minimum test frequency of five years.

Voltage transformers shall comply with the minimum BIL rating as specified in standards IEEE C57.13 and ANSI C12.11. In addition, the dielectric withstand levels shall meet AEP's most recent standard.

Remote Meter Access and Communications

Meter Communications – At AEP's request, the GC, TI or EUC Requester shall provide the appropriate communications for remote interrogation of meters and metering devices satisfactory to AEP.

Remote Terminal Unit (RTU) - See SS-500000 AEP SCADA RTU Requirements for Transmission Interconnection Facilities (Appendix F of "Requirements for Connection of New Facilities or Changes to Existing Facilities Connected to the AEP Transmission System") for more specific requirements.

Freeze Signals – Energy meters shall provide energy pulse accumulators (bi-directional, if required) or energy counters to the RTU (or equivalent device). The energy counters or pulse accumulator data shall be frozen based upon the AEP RTU configuration. The accumulator freeze signal shall be synchronized to Universal Coordinated Time within +/- 2 seconds.

Energy meters shall be equipped with an internal modem for remote interrogation. In addition, the revenue meter shall be equipped with an RS-232 or optical port for local interrogation.

Requestor Access to AEP Metering Circuits

Requester access to AEP metering circuits with metering equipment (check metering) may be acceptable with AEP's approval. Under no circumstances will protective relays be allowed in interconnection metering circuits.

 AMERICAN ELECTRIC POWER <small>BOUNDLESS ENERGY™</small>	<u>TRANSMISSION PLANNING GUIDELINE</u> Requirements for Connection of New Facilities or Changes to Existing Facilities Connected to the AEP Transmission System	Rev. 2	TP-0001
			Page 70 of 99

APPENDIX F

F: AEP SCADA RTU Requirements for Transmission Interconnection Facilities

(NOTE: This Appendix is an AEP Standard and is included for reference. The requestor should obtain the latest copy from AEP at the time of request)

 AMERICAN ELECTRIC POWER <small>BOUNDLESS ENERGY™</small>	TRANSMISSION PLANNING GUIDELINE Requirements for Connection of New Facilities or Changes to Existing Facilities Connected to the AEP Transmission System	Rev. 2	TP-0001
			Page 71 of 99

AEP SCADA RTU Requirements for Transmission Interconnection Facilities

2.0 Purpose	72
3.0 Scope	72
4.0 References	72
5.0 Document Control	73
6.0 Definition of Terms Used in this Document	74
7.0 General RTU Requirements for all Installations	74
7.1 Communication Circuit Requirements	74
7.2 Supervisory Control Requirements	74
7.3 Data Requirements	74
7.3.1 Analog Data	74
7.3.2 Digital (Status) Inputs	74
7.4 Functional Verification	75
7.5 RTU Accessibility	75
7.6 Cost Requirements	75
8.0 RTU Requirements for Transmission Interconnection Facilities operated by AEP	75
8.1 Data Requirements	75
8.1.1 Interconnection-Specific Data from Revenue Metering	75
8.2 Communication Requirements	75
9.0 RTU Requirements for Transmission Interconnection Facilities not operated by AEP	75
9.1 Data Requirements	76
9.1.1 Interconnection-Specific Data from Revenue Metering	76
9.2 Supervisory Control Requirements	76
10.0 RTU Requirements for Generation Facilities Connected to the AEP Transmission Grid	76
10.1 Data Requirements	76
10.1.1 Generation-Specific Analog Data	76
10.1.2 Generation-Specific Digital (Status) Inputs	77
10.2 Supervisory Control Requirements	77

2.0 Purpose

This document serves as a guideline for AEP’s Planning Engineers, Project Managers, Asset Engineers, Design Teams, and Field Support personnel who are assigned to projects involving non-AEP Transmission customers connecting to the AEP transmission grid. This document serves as Appendix F to “Requirements for Connection of New Facilities or Changes to Existing Facilities Connected to the AEP Transmission System.” This document is intended to be used as a complement to the System Planning connection criteria.

3.0 Scope

This document serves as a guideline for the SCADA/RTU requirements for new interconnection-specific applications involving the AEP transmission grid. AEP’s internal station standards (SS) documents shall be used for project specific engineering and design. Requirements by the regional operators (ERCOT, SPP, and PJM) shall take precedence, where applicable in this document.

4.0 References

The following is a list of documents from Protection and Control Asset Engineering which are intended to be used as a complement to the System Planning connection criteria:

- SS-490011 AEP Metering Requirements for Transmission Interconnection Facilities (Appendix E of “Requirements for Connection of New Facilities or Changes to Existing Facilities Connected to the AEP Transmission System”).

	TRANSMISSION PLANNING GUIDELINE Requirements for Connection of New Facilities or Changes to Existing Facilities Connected to the AEP Transmission System	Rev. 2	TP-0001
			Page 72 of 99

- SS-451001 AEP Protection and Disturbance Monitoring Requirements for Connecting to the AEP Transmission Grid (Appendix G of “Requirements for Connection of New Facilities or Changes to Existing Facilities Connected to the AEP Transmission System”).
- SS-500000 AEP SCADA RTU Requirements for Transmission Interconnection Facilities (*This Document*) (Appendix F of “Requirements for Connection of New Facilities or Changes to Existing Facilities Connected to the AEP Transmission System”).

5.0 Document Control

Preparation

ACTION	NAME(S)	TITLE	SIGNATURE & DATE
Prepared by:	D. J. Nudge	Protection & Control Asset Engineering	
Reviewed by:	R. C. Steele	Supervisor I, Protection & Control Asset Engineering	
Approved by:	J. E. Schechter	Manager, Protection & Control Asset Engineering	

Review Cycle

Quarterly	Semi-annual	Annual	As Needed X
-----------	-------------	--------	-------------

Release

VERSION	DATE RELEASED	FILE NAME	CHANGE NOTICE	REMARKS
0	04/19/07	SS-500000.doc	Initial Release	
1	05/18/07	SS-500000.doc	Added one status point to required Generation data point list	
2	05/10/2010	SS-500000.doc	Rewrite to combine East and West Requirements	

Retention Period

Six months	One Year	Two Years	Three Years X
------------	----------	-----------	---------------

6.0 Definition of Terms Used in this Document

- 1) **AEP Transmission (AEP)** – Owner of the transmission grid.
- 2) **Generator Connection (GC)** – Affiliated or non-affiliated generating facility seeking initial connection or an existing connected generating facility that is increasing capacity or operating characteristics.
- 3) **Transmission Interconnection (TI)** – Also known as network interconnection or transmission-to-transmission interconnection. Power is expected to flow in either direction.
- 4) **End-User Connection (EUC)** – Sometimes referred to as a load connection or a transmission load connection. Power is allowed to flow in one direction, from the AEP transmission system to the End-User Requester.

7.0 General RTU Requirements for all Installations

All Supervisory Control and Data Acquisition (SCADA) remote terminal unit (RTU) installations shall meet the following requirements. Additional requirements for each type of interconnection are detailed under the specific sections below.

7.1 Communication Circuit Requirements

A communications circuit including associated interface equipment, as specified by AEP, shall be provided from the RTU to the AEP SCADA Master.

7.2 Supervisory Control Requirements

Control Points, as specified by AEP, from the AEP SCADA RTU shall be provided to the AEP SCADA Master. The Requestor is not permitted to perform controls through the AEP SCADA RTU.

7.3 Data Requirements

An RTU Point Assignment (RPA) shall be compiled by AEP or its authorized agent. All data and control points mapped to the SCADA Master(s) shall be commissioned per Section 7.4. Inputs to the transmission-specific RTU shall be supplied from an AEP-approved interface device or hardwired. RTU inputs from an AEP-approved interface device shall be RS-232 (with optical isolation) or RS-485 using DNP 3.0 protocol. The project-specific RTU points list will be developed by AEP and based upon the following requirements:

7.3.1 Analog Data

- a) MW from each GC, TI and EUC Requester transmission line
- b) MVAR from each GC, TI and EUC Requester transmission line
- c) MVA from each GC, TI and EUC Requester transmission line
- d) Voltage per phase from each GC, TI and EUC Requester transmission line
- e) Distance-to-fault from each GC, TI and EUC Requester transmission line
- f) Current per phase from each GC, TI and EUC Requester transmission line
- g) Current per phase from each GC, TI and EUC Requester transmission line breaker

7.3.2 Digital (Status) Inputs

- a) Transmission line breaker status (required for each GC, TI and EUC Requester line)
- b) Transmission line lockout relay operated (required for each GC, TI and EUC Requester line)
- c) Transmission line lockout relay failure (required for each GC, TI and EUC Requester line)
- d) IED (Intelligent Electronic Device) communications failure (required for each IED sourcing a required point)
- e) Battery charger trouble (required for the battery powering the RTU)
- f) Battery charger AC power failure (required for the battery powering the RTU)
- g) Smoke alarm (required for the structure housing the RTU)
- h) Fire or high temperature alarm (required for the structure housing the RTU)

 AMERICAN ELECTRIC POWER BOUNDLESS ENERGY™	TRANSMISSION PLANNING GUIDELINE Requirements for Connection of New Facilities or Changes to Existing Facilities Connected to the AEP Transmission System	Rev. 2	TP-0001
			Page 74 of 99

7.4 Functional Verification

Prior to placing the interconnecting transmission line(s) in service to the requesting interconnecting company, the RTU shall be fully operational with all data and control points as described in Section 7.3 fully commissioned by AEP.

7.5 RTU Accessibility

The GC, TI and EUC Requester's facility design and operations shall accommodate 24 hour per day accessibility to each AEP RTU by AEP personnel without escort from GC, TI or EUC Requester, facility operator or land owners.

7.6 Cost Requirements

All costs for the procurement, engineering, installation, and commissioning of the RTU and its communication circuit shall be paid by the company requesting the transmission interconnection. In addition, any on-going monthly charges for the required communication circuit shall be paid by the company requesting the transmission interconnection.

8.0 RTU Requirements for Transmission Interconnection Facilities operated by AEP

A transmission-specific Supervisory Control and Data Acquisition (SCADA) remote terminal unit (RTU), specified by AEP, shall be installed at all Transmission Interconnection facilities to be operated by AEP. This transmission-specific RTU shall be engineered, procured, installed, commissioned, and exclusively operated and maintained by AEP or its authorized agents. See "Transmission Interconnection Station" in Figure 1.

8.1 Data Requirements

Data sent to the AEP SCADA Master from the transmission-specific RTU shall include interconnection-specific data from the interconnection revenue metering. Interconnection-specific data shall include the following quantities for each interconnecting transmission line:

8.1.1 Interconnection-Specific Data from Revenue Metering

- a) MWh "Out" (Out = delivered from AEP to the Requester)
- b) MWh "In" (In = received from the Requester to AEP)
- c) MVARh "Out"
- d) MVARh "In"
- e) MW +/- (plus = instantaneous MW from AEP to the Requester)
(minus = instantaneous MW from the Requester to AEP)
- f) MVAR +/-
- g) MVA
- h) Frequency
- i) Instantaneous per phase Voltages (pertaining to each interconnecting transmission line)
- j) Instantaneous per phase Currents (pertaining to each interconnecting transmission line)

The MWh, MVARh, MW, and MVAR units may be displayed in terms of kWh, kVARh, kW, and kVAR at the energy meter. Refer to SS-490011 for more information on Interconnection Metering Requirements.

8.2 Communication Requirements

An additional communication circuit may be provided by the GC, TI or EUC Requester to provide interconnection-specific data (as described in Section 8.1) to their SCADA Master at their cost. The GC, TI or EUC Requester may request a communication port from AEP's transmission-specific RTU to obtain interconnection-specific data to be sent to their SCADA Master or the GC, TI or EUC Requester may install their own RTU to provide interconnection-specific data to be sent to their SCADA Master with communication to the AEP RTU through an available serial communication port.

9.0 RTU Requirements for Transmission Interconnection Facilities not operated by AEP

A Supervisory Control and Data Acquisition (SCADA) remote terminal unit (RTU), specified by AEP, shall be installed at all non-AEP transmission facilities which are to be connected to the AEP transmission grid. This transmission-specific RTU shall be engineered, procured, installed, commissioned, and exclusively operated and maintained by AEP or its authorized agents. As an alternative to installing AEP's standard RTU, AEP may request to have a modem installed and connected to a communication port from the Requester's RTU. See Transmission Interconnection Station in Figure 1.

 AMERICAN ELECTRIC POWER BOUNDLESS ENERGY™	TRANSMISSION PLANNING GUIDELINE Requirements for Connection of New Facilities or Changes to Existing Facilities Connected to the AEP Transmission System	Rev. 2	TP-0001
			Page 75 of 99

9.1 Data Requirements

If AEP's standard RTU is installed, inputs to the transmission-specific RTU shall be supplied from an AEP-approved interface device or hardwired. RTU inputs from an AEP-approved interface device shall be RS-232 (with optical isolation) or RS-485 using DNP 3.0 protocol. Data provided from the transmission-specific RTU (or communications port of the Requester's RTU) to the AEP SCADA Master shall include the following interconnection-specific data for each interconnecting transmission line:

9.1.1 Interconnection-Specific Data from Revenue Metering

- a) MWh "Out" (Out = delivered from AEP to the Requester)
 - b) MWh "In" (In = received from the Requester to AEP)
 - c) MVARh "Out"
 - d) MVARh "In"
 - e) MW +/- (plus = instantaneous MW from AEP to the Requester)
(minus = instantaneous MW from the Requester to AEP)
 - f) MVAR +/-
 - g) MVA
 - h) Frequency
 - i) Instantaneous per phase Voltages (pertaining to each interconnecting transmission line)
 - j) Instantaneous per phase Currents (pertaining to each interconnecting transmission line)
- The MWh, MVARh, MW, and MVAR units may be displayed in terms of kWh, kVARh, kW, and kVAR at the energy meter. Refer to SS-490011 for more information on Interconnection Metering Requirements.

9.2 Supervisory Control Requirements

If the AEP SCADA Master is to have supervisory control capability at the Requester's interconnection facility, then the standard AEP SCADA RTU shall be installed at the facility for controls and data to the AEP SCADA Master. AEP shall only perform controls through SCADA RTUs for which it has exclusive operational, maintenance and compliance responsibility.

10.0 RTU Requirements for Generation Facilities Connected to the AEP Transmission Grid

In addition to the transmission-specific RTU at the Transmission facility, a generation-specific RTU, specified by AEP, may be required at interconnected generation facilities to provide generation-specific Supervisory Control and Data Acquisition (SCADA) to the AEP SCADA Master. This generation-specific RTU shall be engineered, procured, installed, commissioned, and exclusively operated and maintained by AEP or its authorized agents. Reference Generation Facility in Figure 1.

10.1 Data Requirements

Inputs to the generation-specific RTU shall be supplied from an AEP-approved interface device or hardwired as specified below. RTU inputs from an AEP-approved interface device shall be RS-232 (with optical isolation) or RS-485 using DNP 3.0 protocol. The project-specific RTU points list will be developed by AEP and based upon the following requirements:

10.1.1 Generation-Specific Analog Data

- a) Generator gross MW (required for each thermal-powered generation unit)
- b) Generator gross MVAR (bi-directional values required for each thermal-powered generation unit)
- c) Generator station use MW auxiliary (required for each auxiliary transformer)
- d) Generator station use MVAR auxiliary (bi-directional values required for each auxiliary transformer)
- e) Station frequency HZ (for those stations where a common bus does not exist between multiple generation units, individual unit frequency points will be required)
- f) Voltage per phase for each winding of each transformer
- g) Current per phase for each winding of each transformer
- h) MW for each winding of each transformer
- i) MVAR for each winding of each transformer (bi-directional values required)

 AMERICAN ELECTRIC POWER BOUNDLESS ENERGY™	TRANSMISSION PLANNING GUIDELINE Requirements for Connection of New Facilities or Changes to Existing Facilities Connected to the AEP Transmission System	Rev. 2	TP-0001
			Page 76 of 99

- j) MW for each circuit breaker/switcher
- k) MVAR for each circuit breaker/switcher (bi-directional values required)
- l) MW for each collection feeder
- m) MVAR for each collection feeder (bi-directional values required)
- n) Voltage per phase of each collection feeder
- o) Voltage per phase of each shunt device (capacitor and reactor)
- p) MVAR for each shunt device (capacitor and reactor) (bi-directional values required)
- q) Tap position for each power transformer
- r) Dynamic MVAR capability at the current MW generation amount (required for each dynamic reactive controller)
- s) Voltage set point for each dynamic reactive controller
- t) Power factor set point for each dynamic reactive controller

10.1.2 Generation-Specific Digital (Status) Inputs

- a) Generator breaker status (hardwired for each breaker where Trip control is required)
- b) Transformer high-side breaker status (hardwired for each breaker where Trip control is required)
- c) Supervisory cutoff (hardwired for each breaker where Trip control is required)
- d) Breaker failure lockout status (hardwired for each breaker where Trip control is required)
- e) Circuit switcher / line switch status (“a” and “b” contacts)
- f) Transformer high-side motor operated switch status (“a” and “b” contacts)
- g) Auxiliary breaker status
- h) Collection feeder breaker status
- i) Tie breaker status
- j) Shunt device (capacitor and reactor) breaker/switch status
- k) Dynamic reactive controller (off/on)
- l) Dynamic reactive controller (manual/auto)
- m) Dynamic reactive controller (voltage/power factor)
- n) Breaker critical alarm (required for each breaker where Trip control is required, combine critical alarms for each breaker)
- o) Transformer critical alarm (combine critical alarms for each transformer)
- p) Transformer primary lockout relay operated
- q) Transformer primary lockout relay failure
- r) Transformer backup lockout relay operated
- s) Transformer backup lockout relay failure
- t) Generator automatic voltage regulator (AVR) status
- u) Black start availability
- v) Fault recorder trouble alarm

10.2 Supervisory Control Requirements

A Trip control shall be provided for one or more of the generation or transmission line breakers to provide the AEP SCADA Master with the ability to trip all generation units during system emergencies. This trip control shall be hardwired and have corresponding Digital (Status) Inputs that are also hardwired (see Section 10.1 for Status Inputs).

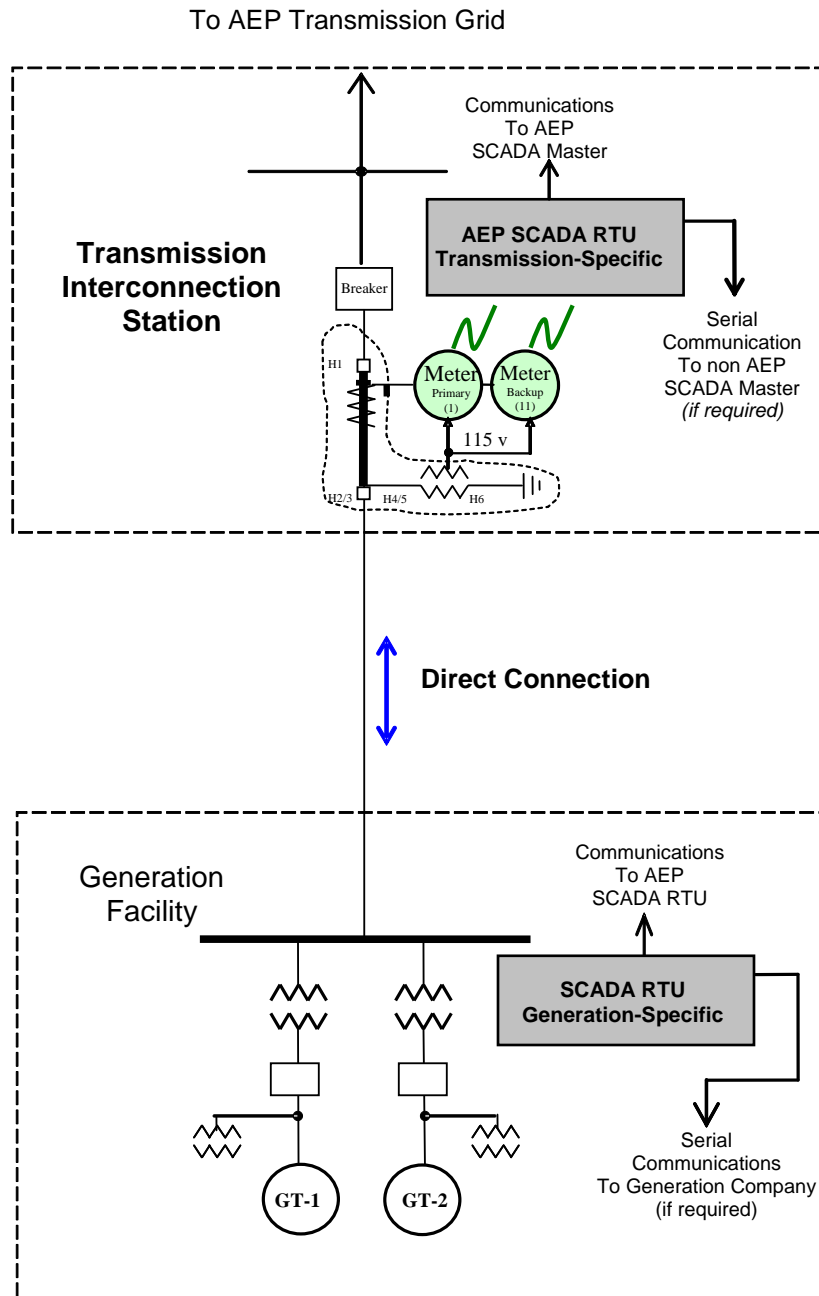



Figure 1
Transmission-Specific and Generation-Specific RTU's
For AEP Transmission Interconnections

In retrofit situations, a specific generation monitoring device will be relocated, such as replacing an obsolete AEP fault recorder in the Generator's plant with an SDR/DME in the AEP substation subject to Disturbance Monitoring Requirements identified in Section 2.15.

APPENDIX G

G: AEP Protection and Disturbance Monitoring Requirements for Connecting to the AEP Transmission Grid

(NOTE: This Appendix is an AEP Standard and is included for reference. The requestor should obtain the latest copy from AEP at the time of request)

 AMERICAN ELECTRIC POWER <small>BOUNDLESS ENERGY™</small>	TRANSMISSION PLANNING GUIDELINE Requirements for Connection of New Facilities or Changes to Existing Facilities Connected to the AEP Transmission System	Rev. 2	TP-0001
			Page 79 of 99

Appendix G – AEP Protection and Disturbance Monitoring Requirements

CAUTION: Printed copies of this document are uncontrolled and may be obsolete.

Always check for the latest revision prior to use.

REVISION HISTORY 81

1.0 General 82

2.0 Requester Protection..... 82

3.0 Grounding of Requester’s Facilities 82

4.0 Transmission Line Protection Pilot Channel Requirements 82

5.0 AEP Terminals at Remote End of The Requester’s Station 82

6.0 Customer Tapped Stations And Fused Transformer Applications 83

7.0 Tapped Stations Added To Lines With Carrier 83

8.0 Automatic Under frequency Load Shedding 83

9.0 SCADA Considerations 83

9.1 Remote Relay Access 83

10.0 Environmental Considerations 84

11.0 Fault Disturbance Monitoring 84

12.0 Power Supply For Protective Relaying 84

13.0 High Speed Ground Switch Applications (HSGS)..... 84

14.0 Testing and Maintenance..... 84

15.0 Requester With Facilities That Are Generation Source..... 85

 15.1 Ground Current Sources 85

 15.2 Automatic Reclosing 85

 15.3 Frequency Protection..... 85

16.0 Subsynchronous Oscillation Monitoring and Relaying Placement 85

Appendix G – AEP Protection and Disturbance Monitoring Requirements

CAUTION: Printed copies of this document are uncontrolled and may be obsolete.

Always check for the latest revision prior to use.

PURPOSE

This document is intended to guide AEP Engineers who are involved in the process of connecting any facilities to the AEP Transmission grid. This serves as minimum requirements for both internal AEP and external customer facilities. This provides Planning Engineers, Project Managers, Asset Management personnel, Design Teams and Field Services personnel with the minimum Protection and Control (P&C) requirements. These requirements are vital in establishing a reliable connection to the AEP grid in a manner that is cost-effective, and compatible with the rest of the AEP transmission grid. This document is intended to complement the System Planning connection criteria. This document addresses the specifics of protection requirements while the Transmission Planning Connection Guide addresses protection in very general terms. This document serves as Appendix G to “Requirements for Connection of New Facilities or Changes to Existing Facilities Connected to the AEP Transmission System.”

SCOPE

This document addresses not only the general protection and control requirements but also addresses specific protection and control applications and protection requirements for more specific circumstances. However, this does not address the requirements at a schematic or relay model level. Design and testing requirements are addressed for not only protection but also data systems, Supervisory Control and Data Acquisition (SCADA), telecommunications, and reclosing. It also addresses a few schedule coordination and other logistical considerations between the customer and AEP.

REFERENCES

There was no legacy AEP or CSW P&C standard that this supersedes. However, the following Transmission Planning Documents were used as starting points for development, and this standard is compatible and complements these Planning Guides:

- CSW Guidelines for Generation, Transmission and Transmission Electricity End-Users Interconnection Facilities. March 2000.
- AEP Requirements For Connection of Non-Generation Facilities To The AEP transmission system. March, 2000
- AEP Requirements for Connection of Generation facilities to the AEP transmission system. May, 1999.
- AEP “In-Line” Facility Policy and Guideline for Generation and Non-Generation Transmission Customers. May 2002.

Other References Include:

- Station Standard #SS 420410. P&C Testing and Maintenance.
- AEP Metering Requirements for Transmission Interconnection Facilities SS# 490011
- AEP SCADA RTU Requirements for Transmission Interconnection Facilities SS# 500000
- Substation Data Repository System SS# 501107
- ANSI/IEEE Standard C37.90

REVISION HISTORY

Rev.	Description of Change(s)	By	Date	Approved
0	Original Issue	Dan Recker	1-24-03	DJR
1	Page 3, SCADA CONSIDERATION section, added clarifying sentence. PURPOSE, pg 1, clarified.	Dan Recker	4-19-03	DJR
2	Page 3, added a section that explicitly addresses fuses	Dan Recker	9-10-05	DJR
3	Revised the Frequency Protection section on page 6, made some small editing changes, and added some new references.	Henry Miller	3-25-07	JAS

 AMERICAN ELECTRIC POWER BOUNDLESS ENERGY™	<u>TRANSMISSION PLANNING GUIDELINE</u> Requirements for Connection of New Facilities or Changes to Existing Facilities Connected to the AEP Transmission System	Rev. 2	TP-0001
			Page 81 of 99

1.0 General

AEP will provide functional specifications and relay settings for all protective relays at the **Requester’s** facility that have a potential impact on the reliability of the AEP transmission system. The criteria for these functional specifications and settings will be based on existing AEP protection practices and standards. AEP reserves the right to specify the type and manufacturer for these protective relays to ensure compatibility with existing relays. The specific recommendations and requirements for protection will be made by AEP based on the individual station location, voltage and configuration. AEP further reserves the right to modify relay settings when deemed necessary to avoid safety hazards to utility personnel or the public and to prevent any disturbance, impairment, or interference with AEP’s ability to serve other customers. All relays specified for the protection of the AEP system, including time delay and auxiliary relays, shall be approved by AEP, and shall be utility grade devices. Utility grade relays are defined as follows:

- Meet ANSI/IEEE Standard C37.90, “Relays and Relay Systems Associated with Electric Power Apparatus”
- Have relay test facilities to allow testing without unwiring or disassembling the relay.
- Have appropriate test plugs/switches for testing the operation of the relay.
- Have targets to indicate relay operation.

2.0 Requester Protection

It is the Requester’s responsibility to assure protection, coordination and equipment adequacy within their facility for conditions including but not limited to:

- Single phasing of supply
- System faults
- Equipment failures
- Deviations from nominal voltage or frequency
- Lightning and switching surges
- Harmonic voltages
- Negative sequence voltages
- Separation from AEP supply
- Synchronizing generation.
- Resynchronizing of Requestors generation (ie. islanding) after restoration of supply

3.0 Grounding of Requester’s Facilities

Requester’s protection and control equipment interfacing with AEP protection and controls must be solidly tied to a common ground. Grounding of equipment must be consistent with IEEE standards.

4.0 Transmission Line Protection Pilot Channel Requirements

High speed transmission line protection and transfer trip functionality requires pilot channel communication links between the line terminals. The types of pilot channel communication links can include, but are not limited to the following: Power line carrier, fiber optic cable, radio, and pilot wire. Critical and sensitive portions of the transmission grid commonly require transfer trip and/or dual high-speed protection, which requires two separate pilot channel links. The specific recommendations and requirements for these pilot channels will be based on AEP protection practices and standards. AEP reserves the right to determine when transfer trip is necessary and to select either single or dual high-speed systems and to specify the type and characteristics of the pilot channel to ensure compatibility with the existing protection.

5.0 AEP Terminals at Remote End of The Requester’s Station

The protection at all ends of a transmission line must be compatible and function as a system. Thus, the installation or modification of transmission line protection at the **Requester’s** station may require the upgrade or replacement of protection at the remote terminals. Such upgrades or replacements at the remote terminals shall be considered within the project scope for the Requester’s station, and funded, accordingly.

	<p><u>TRANSMISSION PLANNING GUIDELINE</u> Requirements for Connection of New Facilities or Changes to Existing Facilities Connected to the AEP Transmission System</p>	Rev. 2	TP-0001
			Page 82 of 99

6.0 Customer Tapped Stations and Fused Transformer Applications

For public safety and the protection of the grid infrastructure, AEP sets line protection to clear line faults as fast as possible, and thus, does not intentionally delay this line protection to coordinate with down line tapped fuses. Similarly, AEP has an obligation to have a fuse connection policy that ensures reliable zone-to-zone relay coordination for the reliability of all AEP customers connected to the grid. To achieve this, transformer fuses are generally not applied on tapped lines with pilot protection or lines with short circuit fault current above 15kA (to stay under the short circuit fault limit of most fuses). To achieve this, fuses are not permitted at transmission line voltages of 138kv and above. At subtransmission voltages, fuses sized to carry more than 10 MVA transformer load rarely coordinate with AEP line protection, and therefore, are not permitted. For all other potential fuse application requests, AEP will recommend a fuse size that will coordinate with the existing line protection, if one can be found. It will be the connecting customer's responsibility to coordinate and operate below this specified fuse limit. If AEP cannot find a fuse that reliably coordinates with the existing line protection, or if the recommended fuse size is unacceptable to the customer, then the customer will need to upgrade the transformer high-side interrupting device to a circuit switcher or breaker. AEP reserves the right to require the customer to replace the fuse with an upgraded interruption device if the fuse performance is found to adversely impact grid reliability or if grid and line protection conditions change.

7.0 Tapped Stations Added To Lines with Carrier

Carrier signals can be degraded by tapped load and load that is electrically located at the ¼ wavelength of the carrier frequency on the line. It is not practical to accurately predict in advance whether newly tapped load will create this condition. A wave trap installed at the new tap is one way of insuring that newly tapped load will not adversely affect the line carrier signal. It is the responsibility of the delivery point Requester to insure that the new delivery point does not degrade the power line carrier signal(s) or protection scheme on the tapped line. This may require a wave trap to be installed on the appropriate phase at the tap to the Requester's station and tuned to the carrier frequency. The Requester can choose to install this wave trap in advance or determine at the point of energizing the newly tapped station whether a wave trap is necessary. If the Requester elects not to install the wave trap in advance, and it is later determined that the tapped installation has degraded the carrier signal(s), then the delivery point will be de-energized until such time that the tapped station has been modified to eliminate the source of carrier signal degradation.

8.0 Automatic Under frequency Load Shedding

The RTO may require an automatic load shedding scheme on connected load to comply with North American Electric Reliability Corporation (NERC) standards or other system stability considerations. AEP is obligated to have an automatic under frequency load shedding plan in effect, which meets these NERC standards. Connecting parties without an automatic under frequency load shedding plan for meeting these NERC requirements may need to install under frequency relaying and have a load shedding program in place as required by the RTO. The amount of load to be shed and frequency set points will be specified by AEP/RTO as set forth in the under frequency load shedding compliance requirements of NERC and the applicable Regional Reliability Organization.

9.0 SCADA Considerations

Supervisory Control and Data Acquisition (SCADA) is an essential tool for reliably controlling and monitoring the transmission protective relays. *See SS-500000 AEP SCADA Requirements for Transmission Interconnection Facilities for more specific requirements.*

9.1 Remote Relay Access

- **Tap Connected Facilities** - Remote relay access is not normally required at tap connected facilities.
- **Loop or Network Connected Facilities** - All digital relays which have the capability of recording system disturbance information and are used for protection of AEP transmission facilities shall be provided with the equipment necessary to allow AEP to remotely retrieve this data via Requester equipment. The type of communications circuit will need to meet all NERC Critical Infrastructure Protection (CIP) reliability standards.

	TRANSMISSION PLANNING GUIDELINE Requirements for Connection of New Facilities or Changes to Existing Facilities Connected to the AEP Transmission System	Rev. 2	TP-0001
			Page 83 of 99

10.0 Environmental Considerations

The performance and durability of modern protective relays is impacted by their surrounding environment, and can be especially impacted by extreme high and low ambient temperatures. Consequently, protection that can potentially impact the AEP transmission grid must be installed in a climate controlled environment consistent with AEP specifications.

11.0 Fault Disturbance Monitoring

AEP is responsible to meet the NERC and Regional Entity disturbance monitoring and reporting (DME) requirements. AEP reserves the right to specify the type, model and specifications of the disturbance monitoring equipment necessary to meet all applicable regulatory and AEP internal requirements. The Requester is responsible to meet the NERC and Regional Entity disturbance monitoring requirements for all the Requestor-owned facilities.

12.0 Power Supply for Protective Relaying

All protection systems, disturbance monitors and SCADA systems at the Requester’s facilities that can potentially impact the AEP transmission grid must have a source of power independent from the AC system or immune to AC system loss or disturbances (e.g., DC battery and charger) to assure proper operation of the protection schemes. Loss of this source shall require the immediate disconnection from the AEP transmission grid until the source is restored.

13.0 High Speed Ground Switch Applications (HSGS)

HSGSs shall not be used as the primary means of fault clearing. Under certain rare conditions, it may be permissible to apply HSGSs as a backup means of fault clearing provided that the Requester pays for any resulting damages or liabilities created by the operation of the HSGS. Approval of HSGS applications on Requester’s facilities connected to the AEP transmission grid will be at the discretion and approval of AEP after factoring all of the reliability and operational considerations.

14.0 Testing and Maintenance

All Requester-owned equipment up to and including the first protective fault interrupting device is to be maintained to AEP standards. Maintenance specifications are detailed in the Station Standard #SS 420410, P&C Testing and Maintenance, and Station Standard #SS 420310, Circuit Breaker Maintenance.

The Requester shall have an organization approved by AEP test and maintain all devices and control schemes provided by the Requester for the protection of the AEP system. Included in the testing and maintenance will be any initial set up, calibration, and check out of the required protective devices, periodic routine testing maintenance, and any testing and maintenance caused by a Requester or AEP change to the protective devices. All maintenance and testing requirements implied above must be done in accordance with NERC standards so that the Requester remains compliant with NERC reliability standards.

If the Requester’s testing and maintenance program is not performed in accordance with AEP’s “Guidelines for Transmission and Distribution Maintenance and Frequencies,” AEP reserves the right to inspect, test, and maintain the protective devices required for the protection of the AEP System. AEP utilizing the right to inspect, test, and maintain the Requester’s equipment does not mitigate the Requester’s status with NERC compliance.

It is the responsibility of the Requester to know and remain current with all applicable NERC reliability standards to which they must comply.

All costs associated with the testing and maintenance of devices provided by the Requester for the protection of the AEP system, including costs incurred by AEP in performing any necessary tests or inspections, shall be the responsibility of the Requester.

AEP reserves the right to approve the testing and maintenance practices of a Requester when the End-User’s system is operated as a network with the AEP transmission system.

	<p><u>TRANSMISSION PLANNING GUIDELINE</u> Requirements for Connection of New Facilities or Changes to Existing Facilities Connected to the AEP Transmission System</p>	Rev. 2	TP-0001
			Page 84 of 99

15.0 Requester with Facilities That Are Generation Source

Generating sources present some unique considerations as follows:

15.1 Ground Current Sources

Protective relays must be able to sense line-to-ground faults. Ground fault protection is predicated upon having an adequately grounded transmission grid with suitable zero sequence ground fault current levels. This requires that transformers connected to the transmission grid be specified and connected in a manner that provides for adequate zero sequence ground fault current. AEP reserves the right to specify the zero sequence impedance requirements that the transformer and its connection to the transmission grid must meet, and reserves the right to require a delta tertiary winding on the transformer for providing a compatible configuration.

15.2 Automatic Reclosing

Automatic reclosing is normally applied to transmission and distribution circuits. When the AEP source breakers trip and isolate the Requester's facilities, the Requester shall ensure that its generator is disconnected from AEP prior to automatic reclosure by AEP. Automatic reclosing out-of-phase with the Requester's generator may cause damage to the Requester's equipment. The Requester is solely responsible for the protection of their equipment from automatic reclosing by AEP. Black start requirements may involve additional synchronizing equipment.

15.3 Frequency Protection

Generator under frequency protection must be set to coordinate with the settings of the NERC-mandated automatic load shedding protection. Thus, the generator under frequency protection must not operate before the system under frequency load shed protection has a chance to respond. The Requester is responsible for setting their generator under frequency protection to comply with the local Area Reliability council's requirements for generator under frequency protection.

16.0 Subsynchronous Oscillation Monitoring and Relaying Placement

AEP will install Subsynchronous Oscillation Monitoring and Relaying at all point of interconnects within the AEP-owned station for all generation located near series capacitor banks. AEP may install Subsynchronous Monitoring and Relaying at a station located on weak portions of the system where the X/R ratio is lower than 5. The Subsynchronous Oscillation Monitoring and Relaying will be placed in monitoring mode and only set to trip if there are known oscillations that impact other customers on the grid.

 AMERICAN ELECTRIC POWER® BOUNDLESS ENERGY™	TRANSMISSION PLANNING GUIDELINE Requirements for Connection of New Facilities or Changes to Existing Facilities Connected to the AEP Transmission System	Rev. 2	TP-0001
			Page 85 of 99

APPENDIX H

H: Transmission Switching Guidelines for In-Line Stations

 <small>BOUNDLESS ENERGY™</small>	<u>TRANSMISSION PLANNING GUIDELINE</u> Requirements for Connection of New Facilities or Changes to Existing Facilities Connected to the AEP Transmission System	Rev. 2	TP-0001
			Page 86 of 99



AEP Guide for Application of In-Line Manual Air Break Switches, Automatic Air Break Switches or Circuit Breakers

September 2005

 AMERICAN ELECTRIC POWER <small>BOUNDLESS ENERGY™</small>	<u>TRANSMISSION PLANNING GUIDELINE</u> Requirements for Connection of New Facilities or Changes to Existing Facilities Connected to the AEP Transmission System	Rev. 2	TP-0001
			Page 87 of 99

REVISION HISTORY

Rev.	Description of Change(s)	Prepared or Revised By	Date	Approved
0	Original Issue	M. Ahmed	September 2005	B. M. Pasternack
1				
2				
3				
4				

Appendix H – Transmission Switching Guidelines

CAUTION: Printed copies of this document are uncontrolled and may be obsolete.

Always check for the latest revision prior to use.

Table Of Contents

1.0 Introduction..... 90

2.0 Background..... 90

3.0 Scope..... 90

4.0 Objectives 90

5.0 References..... 91

6.0 Tap Connection Definition..... 91

7.0 In-Line Switching Facilities Definition and Requirements..... 91

8.0 Selection of In-Line Switching Device(s) to Connect LOAD to the Transmission System..... 91

 8.1 Basic Service Plan..... 92

 8.2 Justification for In-Line MOAB Switches 92

 8.3 Justification for In-Line Circuit Breaker (CB)..... 92

1.0 Introduction

American Electric Power, acting on behalf of the eleven American Electric Power (AEP) Operating Companies⁶, has prepared this document which outlines the methodology for determining the minimum switching/sectionalizing equipment requirements for an in-line connection of all transmission load facilities to the AEP transmission system below 200 kV. In-line connection refers to the connection of load at a point located in series with the through path of a transmission circuit. **Transmission Load (load)**⁷ facilities refer to the facilities that need to be installed to establish connections between AEP and the radially served loads (direct connections to End-Users or the delivery points of wholesale customers such as municipalities, co-operatives, or AEP Distribution), by tapping the transmission circuit and installing sectionalizing facilities.

2.0 Background

In the present electric utility environment characterized by deregulation, open access to the transmission network, wholesale and retail competition, etc., there is a wide recognition that electric system reliability, safety and quality of service are to be maintained. Maintaining reliability, safety and quality of service in this changing environment presents additional challenges to those involved in the planning and operation of electric systems.

As a result of this environment, there are an increasing number of requests to connect to and use the AEP transmission system. Each request is reviewed by AEP to identify the impacts and necessary system improvements on the AEP transmission system. The purpose of this document is to ensure that comparable treatment is given to all users, and that reliability, safety, and quality of service are maintained.

3.0 Scope

This appendix conveys information about the in-line switching requirements for connection to parties seeking connection of load to the AEP transmission system. The methodology and the requirements are applicable to all radially connected load including AEP Distribution load as well as the load served by wholesale and retail customers, connecting to AEP transmission lines below 200 kV. These requirements are not a substitute for specific Service Agreements between AEP and non-affiliated entities connecting to the AEP transmission system. The requirements described in this appendix do not apply to generation facility connections, interconnection tie lines with other Utilities, or connection of a radial customer directly to an AEP Transmission Station. This appendix contains guidelines for the minimum switching requirements that should be adhered to when connecting load facilities to AEP’s transmission system operated below 200 kV. Connections to the transmission system above 200 kV are not included and will be addressed on a case-by-case basis. Reliability, power quality and operational concerns may impose the need to install additional “in-line” sectionalizing facilities. The need for appropriate switching requirements can only be evaluated once certain details of a proposed load facility are made known and studies have been conducted.

The requirements for initial facility connection also apply to any upgrades, additions, enhancements, or changes of any kind to an existing connected facility.

This document does not cover transmission service or deliverability. The **load** connection entities requiring transmission service should refer to the AEP, PJM, ERCOT, and SPP Open Access Transmission Tariffs.

4.0 Objectives

AEP, in its role as a transmission owner, has prepared this document to accomplish the following objectives:

1. Inform those entities that request electric service to their loads from the AEP transmission system of the need for minimum in-line sectionalizing facilities required at the point of connection.
2. Maintain adequate system reliability, safety of personnel/equipment, and quality of service.
3. Ensure comparability in the requirements imposed upon the various load-serving entities, including individual customers, seeking to connect to the AEP transmission system for service.
4. Facilitate uniform and compatible minimum sectionalizing equipment requirements and installation practices to promote and/or maintain a basic level of service reliability.

⁶ Appalachian Power Company, Columbus Southern Power Company, Indiana Michigan Power Company, Kentucky Power Company, Kingsport Power Company, Ohio Power Company, Public Service Company of Oklahoma, Southwestern Electric Power Company, Texas Central Company, Texas North Company and Wheeling Power Company.

⁷ **Transmission Load** is hereinafter referred to as **load**.

	<p>TRANSMISSION PLANNING GUIDELINE Requirements for Connection of New Facilities or Changes to Existing Facilities Connected to the AEP Transmission System</p>	<p>Rev. 2</p>	TP-0001
			Page 90 of 99

5.0 References

The following documents were used to develop these guidelines, which are compatible with and complement the reference Guides:

1. Requirements for Connection of Non-Generation Facilities to the AEP Transmission System. (TP-000001; June 2004)
2. Motor Operated Air Break Switches. (SS-476010; January 2003)

6.0 Tap Connection Definition

Any connection to the AEP transmission system that results in only the associated load passing through the connecting facilities under all conditions is considered a tap connection. If the **Requesting Entity's**⁸ facilities are located near an existing AEP station, the connection from the AEP transmission system may be provided by constructing a radial line from the AEP station to the Requester's facility. If the Requester's facilities are located near an existing AEP transmission line, the connection from the AEP transmission system may be provided by tapping the nearby AEP line and constructing a radial line to the Requester's facility (Ref: TP-0000001). This arrangement will provide a radial connection to the Requester but will also result incidentally in creating in-line facilities at the tap point. The in-line facilities will not only carry customer load but also the transmission system power flows.

For facilities below 200 kV, Figures 1 and 2 in the Appendix A (detailed information is contained in “TP-000001”) illustrate typical radial line supply configurations and some of the basic connection requirements to the AEP transmission line. Other possibilities exist depending on the particular situation.

Typically, a manual three-phase air break line switch (switch) on either side of the tap location point is the minimum requirement. The tap line switch can disconnect the **load connection** without de-energizing the supply line. Additionally, in-line air break switches allow for manually sectionalizing the line without supply interruption to the **load**. Automatic motor operated mechanisms (with or without supervisory control) can be added to in-line switches, when justified, to minimize the time required for restoration following a failure of the AEP supply line.

7.0 In-Line Switching Facilities Definition and Requirements

Any connection to the AEP transmission system would require, as a minimum, line disconnect switches, commonly referred to as “Group Operated Air Break (GOAB)” switches. These switches are manually operated and not part of the overall system automatic relaying sectionalizing scheme. The only exceptions to this minimum requirement where switches are not required are the following situations: 1) the connection established to serve load is temporary and is required for a period less than a year; 2) the topography of the tap location is such that the tap is not accessible by road, in which case the in-line switches could be placed elsewhere in a more accessible location, or 3) the tapped in-line connection is required temporarily under emergency system conditions.

A GOAB switch that is equipped with automatic line sectionalizing capability is commonly referred as a “Motor Operated Air Break (MOAB)” switch. A MOAB is simply an air break switch whose blade moves by action of a motor. If the motor turns in one direction, the blade moves to an open position. If the motor turns in the opposite direction, the blade moves to a closed position. MOABs are frequently used on the AEP System below 200 kV as “automatic sectionalizing devices” in addition to their application in the isolation of transformers or lines emanating from the station busses. In some applications, MOABs can be operated remotely by supervisory control. The MOAB is more expensive to install than a GOAB because of the added cost of relaying, supervisory control capability and automatic sectionalizing capability.

The Circuit Breaker (CB), as used in a transmission system, is a device that provides high-speed automatic sectionalizing capability to make or break circuits under normal conditions. A CB can also interrupt fault currents. This automatic sectionalizing by CBs is done with as little disturbance as possible to the system. In general, a CB is inherently more reliable than a MOAB in protecting against false trips, particularly for intermittent line faults. The cost to install a CB is greater than that of a MOAB or GOAB due its more sophisticated sectionalizing capability and function, as well as greater land requirements.

8.0 Selection of In-Line Switching Device(s) to Connect LOAD to the Transmission System

Any plan to serve load from an AEP Transmission Line involves establishing a connection point. At the connection point, appropriate facilities are required to provide adequate service to the new customer while maintaining service reliability and quality to other customers served from the subject transmission line. Several factors are considered in determining the in-line facilities requirement over and above the minimum requirement of GOAB switches. The factors that influence the decision include: 1) the magnitude of load affected; 2) the exposure to fault conditions, i.e. the line length between two automatic sectionalizing devices; and 3) the probability of an outage of the transmission line involved.

⁸ **Requesting Entity** – can refer to either a **Transmission Interconnection Requester** or a **Transmission Load Connection Requester** and hereinafter is referred to as a **Requester**.

	<p align="center"><u>TRANSMISSION PLANNING GUIDELINE</u> Requirements for Connection of New Facilities or Changes to Existing Facilities Connected to the AEP Transmission System</p>	<p align="center">Rev. 2</p>	TP-0001
			Page 91 of 99

8.1 Basic Service Plan

AEP requires that any new plan to connect **load** to the transmission system typically must include **in-line** GOAB switches at the point of connection. This is referred to as the “Basic Plan” and therefore, is the minimum accepted switching arrangement for new connections. The only exceptions to this minimum requirement are described in Section 7.0.

8.2 Justification for In-Line MOAB Switches

Installation of **in-line** MOAB switches at the point where **load** is connected to a transmission system improves the automatic line sectionalizing capability of the circuit and reliability of service to the **load** from a permanent forced outage standpoint. In order to determine if the MOAB switches are required, a factor referred to as the ‘Forced Outage Index (FOI)’ is calculated and compared with the established threshold index values.

The **FOI** is defined as:

$$\text{FOI} = \text{Load (L}_f\text{)} \times \text{Miles of Exposure} \times \text{Permanent Forced Outage Rate (P}_f\text{)}—\text{see explanation below}$$

Where;

L_f = Peak load (in MW) that is directly jeopardized by the forced outage of the subject line

Miles of Exposure = Number of miles between two existing automatic sectionalizing devices (MOABs or CBs) plus new tap line length

P_f = Permanent forced outage rate of the subject line (outages/year/mile). If the outage rate of the subject line is not available, a five year system average outage rate can be used.

Install MOAB switches if the “FOI” is equal to or greater than six (6.0)

The following exceptions apply:

1. The P&C guidelines (“Motor Operated Air Break Switches SS-476010”) require that the number of **in-line** MOAB switches be limited to three (3) on a transmission circuit. If more than three automatic sectionalizing devices are required, installation of a CB is to be considered.
2. AEP reserves the right to disallow application of in-line MOABs where the existing protection system is incompatible with in-line MOABs.
3. AEP reserves the right to request the installation of a Circuit Breaker instead of a MOAB if deemed necessary when considering P&C, physical location, or the critical nature of the transmission line.

8.3 Justification for In-Line Circuit Breaker (CB)

Installation of an **in-line** CB(s) at the point where **load** is connected to a transmission system improves the automatic line sectionalizing capability of the circuit and reliability of service to the **load**, both from the momentary as well as from the permanent forced outage standpoints. In order to determine if a CB is required, a factor referred to as the Momentary Permanent Outage Index (MPOI)’ is calculated and compared with the established threshold index value.

The **MPOI** is defined as:

$$\text{MPOI} = \text{Load (L}_f\text{)} \times \text{Miles of Exposure} \times \text{Forced Outage Rate } \{ \text{Permanent Forced Outage Rate (P}_f\text{)} + \text{Momentary Forced Outage Rate (M}_f\text{)} \}$$

Where;

L_f = Peak load (MW) directly jeopardized by the forced outage of the subject line

Miles of Exposure = Number of miles between two existing automatic sectionalizing CBs, plus new tap line length

Forced Outage Rate (outages/year/mile) = Permanent forced outage rate (P_f) + Momentary forced outage rate (M_f)

Install a CB if the “MPOI” is equal to or greater than two hundred (200).

The following exceptions apply:

	<p><u>TRANSMISSION PLANNING GUIDELINE</u> Requirements for Connection of New Facilities or Changes to Existing Facilities Connected to the AEP Transmission System</p>	Rev. 2	TP-0001 <hr/> Page 92 of 99
---	--	-----------	--------------------------------

Appendix H – Transmission Switching Guidelines

CAUTION: Printed copies of this document are uncontrolled and may be obsolete.

Always check for the latest revision prior to use.

1. In situations where the calculated MPOI is less than 200 and power quality is a concern due to forced momentary outages, installation of a CB can be considered.
2. If the **FOI** calculation (Section 8.2) indicates a justification for a MOAB installation on a circuit that already contains three (3) **in-line** MOAB switches, a CB installation should be considered.
3. If a circuit is critical for overall system reliability or as an outlet for generation, installation of a CB should be considered.

APPENDIX I:

I: Procedures, Studies, and Documentation Required for Interconnection Requests

 <p>AMERICAN ELECTRIC POWER <small>BOUNDLESS ENERGY™</small></p>	<p><u>TRANSMISSION PLANNING GUIDELINE</u> Requirements for Connection of New Facilities or Changes to Existing Facilities Connected to the AEP Transmission System</p>	<p>Rev. 2</p>	<p>TP-0001</p> <hr/> <p>Page 94 of 99</p>
--	---	-------------------	---

1.0 Initiating a Facility Connection or Facility Change

This section identifies the first point of contact in order to request a new facility connection or approval for changes planned to an existing connected facility.

1.0.1 ERCOT Region

Generator Connection Requests:

Requesters of generation with interconnections greater than 10 MW within the ERCOT region of the AEP transmission system can find the necessary information on the ERCOT web site. The applicable link is:

<http://www.ercot.com/services/rq/re/>. Located on this page are the documents for new generation, established generation, and for LaaRs (Load acting as a Resource).

Requesters seeking new or changing small generator (10 MW or less) interconnections within the ERCOT region of the AEP transmission system should contact the AEP Transmission and Interconnection Services Department.

<u>AEP System Contact Information:</u>
Director, Transmission and Interconnection Services American Electric Power Service Corp. 212 East Sixth Street Tulsa, OK 74119 Phone: 918-599-2723 email: rlpennybaker@aep.com

Network Interconnection and End-User Connection Requests:

Requesters seeking new or changing network interconnections or end-user connections within the ERCOT region of the AEP transmission system should contact the AEP Transmission and Interconnection Services Department.

<u>AEP System Contact Information:</u>
Director, Transmission and Interconnection Services American Electric Power Service Corp. 212 East Sixth Street Tulsa, OK 74119 Phone: 918-599-2723 email: rlpennybaker@aep.com

After a network interconnection or end-user connection request is received, AEP will coordinate the required studies in order to identify the system upgrades that will be needed to accommodate the requested interconnection, and initiate the required endorsements from ERCOT. Once the interconnection request has received the required endorsements from ERCOT, AEP will work with the Requester to draft the required Interconnection Agreement (IA).

1.0.2 PJM Region

Generator Connection and Network Interconnection Requests:

All Generator Connection and Transmission Interconnection Requesters seeking to connect to the AEP transmission system should contact the PJM RTO at: <http://pjm.com/>. PJM will coordinate these inquiries with AEP and any other necessary transmission stakeholders. On the PJM website, a collection of information is available including detailed guidance for those seeking to connect to the transmission system in the PJM footprint. Generation companies may review the PJM Manual 14 Series at: <http://pjm.com/planning/generation-interconnection.aspx>, while Merchant Transmission companies may review the PJM Manual 14 Series at: <http://pjm.com/planning/merchant-transmission.aspx>.

After an interconnection request is received from PJM, AEP will conduct the required studies in order to identify the system upgrades that will be needed to accommodate the requested interconnection, and initiate the required endorsements from PJM. Once the interconnection request has received the required endorsements from PJM, AEP will work with the Requester to draft the required Interconnection Agreement.

Appendix I – Procedures, Studies, and Documentation Required for Interconnection Requests

CAUTION: Printed copies of this document are uncontrolled and may be obsolete.

Always check for the latest revision prior to use.

End-User Connection Requests:

Either of the following parties may be contacted regarding new or upgraded transmission service:

<u>AEP System Contact Information:</u>	<u>AEP System Contact Information:</u>
Director, Transmission and Interconnection Services American Electric Power Service Corp. 212 East Sixth Street Tulsa, OK 74119 Phone: 918 -599-2723 Attn: Robert L. Pennybaker rlpennybaker@aep.com	Manager Transmission Customer Engagement American Electric Power Service Corp. 700 Morrison Road Gahanna, OH 43230 Phone: 614-552-1672 Attn: Daniel T Zambory dtzambory@aep.com

1.0.1 SPP Region

Generator Connection Requests

Requesters seeking generator interconnections with the AEP transmission system should contact SPP directly and follow the Interconnection Procedure outlined in Attachment V of the SPP Open Access Transmission Tariff (OATT). The SPP regional OATT can be found using the following link:

http://www.spp.org/publications/SPP_Tariff.pdf

<u>SPP Contact Information for Generator Interconnection Requests:</u>
Manager, Tariff Studies Southwest Power Pool, Inc. 201 Worthen Drive Little Rock, AR 72223-4936

The “Generation Interconnection Studies” portion of the SPP “Planning and System Impact Studies” webpage contains the current versions of the documents that are required for small and large generators to initiate an AEP transmission system interconnection request: <http://sppoasis.spp.org/documents/swpp/transmission/studies.cfm>

Network Interconnection Requests

Requesters seeking new or changing network interconnections within the SPP region of the AEP transmission system should contact the AEP Transmission and Interconnection Services Department.

<u>Contact Information for SPP Region of AEP System:</u>
Director, Transmission and Interconnection Services American Electric Power Service Corp. 212 East Sixth Street Tulsa, OK 74119 Phone: 918-599-2723 email: rlpennybaker@aep.com

End-User Connection Requests

End-Users that consume all energy received should direct interconnection requests to Customer Services and Marketing according to the portion of the AEP transmission system identified for connection.

<u>PSO System Contact Information:</u>	<u>SWEPCO System Contact Information:</u>
Customer Services and Marketing Public Service Company of Oklahoma 212 East Sixth Street Tulsa, OK 74119 Attn: Scott Ritz saritz@aep.com	Customer Services and Marketing Southwestern Electric Power Company 428 Travis St. Shreveport, LA 71101 Attn: Brett Mattison bmattison@aep.com

End-Users that receive energy for resale should direct interconnection requests to the AEP Transmission and Interconnection Services Department.

<u>Contact Information for SPP Region of AEP System:</u>
Director, Transmission and Interconnection Services American Electric Power Service Corp. 212 East Sixth Street Tulsa, OK 74119 Phone: 918-599-2723 email: rlpennybaker@aep.com

After an interconnection request is received, AEP will coordinate the required studies in order to identify the system upgrades that will be needed to accommodate the requested interconnection, and initiate the required endorsements from SPP. Once the interconnection request has been processed and the required endorsements have been obtained from SPP, AEP will work with the Requester to draft the required Interconnection Agreement.

1.1 RTO/ISO Requirements

AEP operating companies are members of three different RTOs/ISOs and the regional requirements, standards, and/or regulations may vary. This section addresses these regional differences.

1.1.1 ERCOT Requirements

Texas North Company and Texas Central Company are members of the ERCOT ISO and, as a condition of membership, have agreed to conform to all approved and applicable ERCOT Texas Regional and North American Electric Reliability Corporation (NERC) Reliability Standards for the Bulk Electric Systems of North America.

The ERCOT website is located at: <http://ercot.com/> and contains information about the ISO functions, service territory, participating members, standards, etc. ERCOT requirements are the foundation of the Connection Request Process, while AEP provides additional requirements specific to connecting to the AEP system. Additional contact information can be found at: <http://www.ercot.com/about/contact/>.

Appendix I – Procedures, Studies, and Documentation Required for Interconnection Requests

CAUTION: Printed copies of this document are uncontrolled and may be obsolete.

Always check for the latest revision prior to use.

1.1.2 PJM Requirements

Appalachian Power, Kentucky Power, Kingsport Power, Indiana Michigan Power, Ohio Power, Columbus Southern Power, Wheeling Power, AEP Appalachian Transmission, AEP West Virginia Transmission, AEP Indiana Michigan Transmission, AEP Kentucky Transmission, and AEP Ohio Transmission Companies are members of the PJM RTO and, as a condition of membership, have agreed to conform to all approved and applicable Reliability First Corporation (RFC) and North American Electric Reliability Corporation (NERC) Reliability Standards for the Bulk Electric Systems of North America.

The PJM RTO home website is located at: <http://pjm.com/> and contains information about the RTO functions, service territory, participating members, standards, etc. PJM requirements are the foundation of the Connection Request Process, while AEP provides additional requirements specific to connecting to the AEP system.

1.1.3 SPP Requirements

Public Service Company of Oklahoma, Southwestern Electric Power Company, AEP Oklahoma Transmission Company, and AEP Southwestern Transmission Company are members of SPP and, as a condition of membership, have agreed to conform to all approved and applicable SPP Regional and North American Electric Reliability Corporation (NERC) Reliability Standards for the Bulk Electric Systems of North America.

The Southwest Power Pool website is located at <http://www.spp.org> and contains information about the RTO functions, service territory, participating members, standards, etc. SPP requirements are the foundation of the Connection Request Process, while AEP provides additional requirements specific to connecting to the AEP system.

<u>SPP Contact Information:</u>
Southwest Power Pool, Inc. 201 Worthen Drive Little Rock, AR 72223-4936 Telephone: 501-614-3200 Facsimile: 501-664-9553 questions@spp.org

The SPP Planning Criteria are adhered to when considering interconnection requests. AEP also maintains planning criteria and the more restrictive criteria will prevail when considering the impacts of new or modified interconnections.

Southwest Power Pool Criteria (Section 3 - Regional Transmission Planning):

<http://www.spp.org/publications/SPP%20Criteria%20and%20Appendices%20July%202013.pdf>

This document is updated frequently. Alternatively, a search for “Criteria” within SPP documents will locate the latest version.

AEP Transmission Planning Criteria (FERC Form 715, Part 4):

<https://www.aep.com/requiredpostings/AEPTransmissionStudies>

1.2 System Study Requirements

After an interconnection request is submitted, and the applicable facility data and monetary deposits are routed to the appropriate recipients, RTO/ISO staff in conjunction with AEP will carry out a series of system studies. This series of studies will continue as long as the request is active, and will be terminated if the request is withdrawn. This series of studies consists of the following:

Feasibility Study

This is a high level evaluation of the proposed interconnection to identify potential problems that may be unacceptable to the stakeholders involved.

System Impact Study

This study is more detailed and is conducted to assess the effects the proposed connection has on transmission system adequacy and reliability. Transmission facility loadings, voltage profiles, power quality impacts, short circuit duties, and transient phenomena are examined over a range of expected system conditions. If the results of this study are acceptable to all stakeholders, a Facility Study will be performed.

Facility Study

 AMERICAN ELECTRIC POWER BOUNDLESS ENERGY™	TRANSMISSION PLANNING GUIDELINE Requirements for Connection of New Facilities or Changes to Existing Facilities Connected to the AEP Transmission System	Rev. 2	TP-0001
			Page 98 of 99

Appendix I – Procedures, Studies, and Documentation Required for Interconnection Requests

CAUTION: Printed copies of this document are uncontrolled and may be obsolete.

Always check for the latest revision prior to use.

This study will review and potentially repeat the System Impact Study and develop the physical connection between the transmission system and a proposed connected facility. The electrical configuration of the connection equipment including transformers, circuit breakers, other station equipment, and required transmission line sections are determined. The physical layout of equipment and right-of-way needs are also determined. Multiple alternatives may be considered when developing facility requirements. Cost estimates of required system upgrades for each alternative are included.

AEP's system performance criteria are detailed in FERC Form 715, Part 4:

<https://www.aep.com/requiredpostings/AEPTransmissionStudies>

These criteria in conjunction with applicable RTO/ISO Planning Criteria are adhered to when assessing the transmission system behavior during normal and emergency system conditions.

 <p>AMERICAN ELECTRIC POWER <small>BOUNDLESS ENERGY™</small></p>	<p><u>TRANSMISSION PLANNING GUIDELINE</u> Requirements for Connection of New Facilities or Changes to Existing Facilities Connected to the AEP Transmission System</p>	<p>Rev. 2</p>	<p>TP-0001</p> <hr/> <p>Page 99 of 99</p>
--	---	-------------------	---